

Serial EEPROM Series Automotive EEPROM

125°C Operation Microwire BUS EEPROM(3-Wire)

BR93Hxx-WC

(2K 4K 8K 16K)

●General Description

BR93Hxx-WC is a serial EEPROM of serial 3-line interface method.

●Features

- Conforming to Microwire BUS
- Withstands electrostatic voltage 8kV, (HBM method typ., except BR93H66RFVM-WC)
- Wide temperature range -40°C to +125°C
- Same package line up and same pin configuration
- 2.7V to 5.5V single supply voltage operation
- Address auto increment function at read operation
- Write mistake prevention function
 - Write prohibition at power on
 - Write prohibition by command code
 - Write mistake prevention circuit at low voltage
- Program cycle auto delete and auto end function
- Program condition display by READY / BUSY
- Low current consumption
 - At write operation (at 5V) : 0.6mA (Typ.)
 - At read operation (at 5V) : 0.6mA (Typ.)
 - At standby condition (at 5V) : 0.1μA(Typ.)(CMOS input)
- Built-in noise filter CS, SK, DI terminals
- High reliability by ROHM original Double-Cell structure
- Data retention for 20 years ($T_a \leq 125^\circ\text{C}$)
- Endurance up to 300,000 times ($T_a \leq 125^\circ\text{C}$)
- Data at shipment all address FFFFh
- AEC-Q100 Qualified

●Packages W(Typ.) x D(Typ.) x H(Max.)

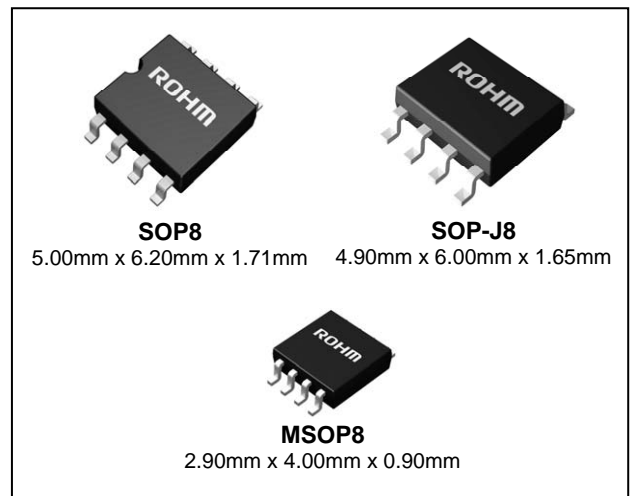

●BR93Hxx-WC

Package type				SOP8	SOP-J8	MSOP8
Capacity	Bit format	Type	Power source voltage	RF	RFJ	RFVM
2Kbit	128 × 16	BR93H56-WC	2.7V to 5.5V	●	●	
4Kbit	256 × 16	BR93H66-WC	2.7V to 5.5V	●	●	●
8Kbit	512 × 16	BR93H76-WC	2.7V to 5.5V	●	●	
16Kbit	1K × 16	BR93H86-WC	2.7V to 5.5V	●	●	

● Absolute Maximum Ratings (Ta=25°C)

Parameter	Symbol	Limits	Unit	Remarks
Impressed voltage	Vcc	-0.3 to +6.5	V	
Permissible dissipation	Pd	0.56 (SOP8)	W	When using at Ta=25°C or higher, 4.5mW, to be reduced per 1°C.
		0.56 (SOP-J8)		When using at Ta=25°C or higher, 4.5mW, to be reduced per 1°C.
		0.38 (MSOP8)		When using at Ta=25°C or higher, 3.1mW, to be reduced per 1°C.
Storage temperature range	Tstg	-65 to +150	°C	
Operating temperature range	Topr	-40 to +125	°C	
Terminal voltage	-	-0.3 to Vcc+0.3	V	

● Memory Cell Characteristics (Vcc=2.7V to 5.5V)

Parameter	Limit			Limit	Limit
	Min.	Typ.	Max.		
Endurance *1	1,000,000	-	-	Times	Ta ≤ 85°C
	500,000	-	-	Times	Ta ≤ 105°C
	300,000	-	-	Times	Ta ≤ 125°C
Data retention *1	40	-	-	Years	Ta ≤ 25°C
	20	-	-	Years	Ta ≤ 125°C

*1 : Not 100% TESTED

● Recommended Operating Ratings

Parameter	Symbol	Limits	Unit
Power source voltage	Vcc	2.7 to 5.5	V
Input voltage	VIN	0 to Vcc	

● Electrical Characteristics (Unless otherwise specified, Ta=-40°C to +125°C, Vcc=2.7V to 5.5V)

Parameter	Symbol	Limits			Unit	Conditions
		Min.	Typ.	Max.		
"L" input voltage	VIL	-0.3	-	0.3x Vcc	V	
"H" input voltage	VIH	0.7x Vcc	-	Vcc + 0.3	V	
"L" output voltage 1	VOL1	0	-	0.4	V	IOL=2.1mA, 4.0V ≤ Vcc ≤ 5.5V
"L" output voltage 2	VOL2	0	-	0.2	V	IOL=100μA
"H" output voltage 1	VOH1	2.4	-	Vcc	V	IOH=-0.4mA, 4.0V ≤ Vcc ≤ 5.5V
"H" output voltage 2	VOH2	Vcc - 0.2	-	Vcc	V	IOH=-100μA
Input leak current	ILI	-10	-	10	μA	VIN=0V to Vcc
Output leak current	ILO	-10	-	10	μA	VOUT=0V to Vcc, CS=0V
Current consumption	ICC1	-	-	3.0	mA	fsk=1.25MHz, tE/W=10ms (WRITE)
	ICC2	-	-	1.5	mA	fsk=1.25MHz (READ)
	ICC3	-	-	4.5	mA	fsk=1.25MHz, tE/W=10ms (WRAL)
Standby current	ISB	-	0.1	10	μA	CS=0V, DO=OPEN

● Operating Timing Characteristics (Unless otherwise specified, Ta=-40°C to +125°C, Vcc=2.7V to 5.5V)

Parameter	Symbol	Min.	Typ.	Max.	Unit
SK frequency	fsk	-	-	1.25	MHz
SK "H" time	tSKH	250	-	-	ns
SK "L" time	tSKL	250	-	-	ns
CS "L" time	tCS	200	-	-	ns
CS setup time	tCSS	200	-	-	ns
DI setup time	tDIS	100	-	-	ns
CS hold time	tCSH	0	-	-	ns
DI hold time	tDIH	100	-	-	ns
Data "1" output delay time	tPD1	-	-	300	ns
Data "0" output delay time	tPD0	-	-	300	ns
Time from CS to output establishment	tSV	-	-	200	ns
Time from CS to High-Z	tDF	-	-	200	ns
Write cycle time	tE/W	-	7	10	ms
Write cycle time (BR93H66RFVM-WC)	tE/W	-	-	5	ms

● Sync data input / output timing

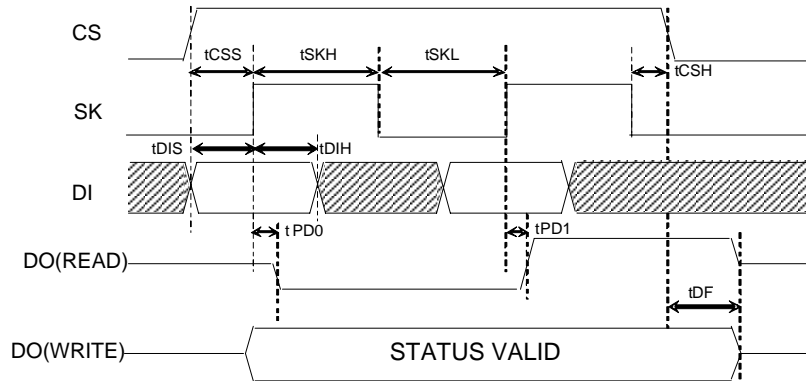

○Data is taken by DI sync with the rise of SK.

○At read operation, data is output from DO in sync with the rise of SK.

○The status signal at write (READY / $\overline{\text{BUSY}}$) is output after tCS from the fall of CS after write command input, at the area DO where CS is "H", and valid until the next command start bit is input. And, while CS is "L", DO becomes High-Z.

○After completion of each mode execution, set CS "L" once for internal circuit reset, and execute the following operation mode.

●Block Diagram

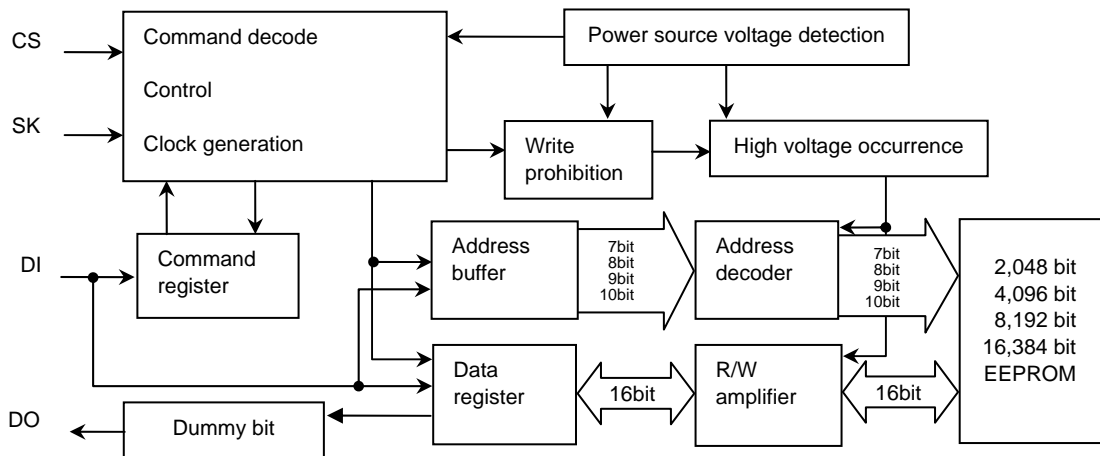

●Pin Configurations

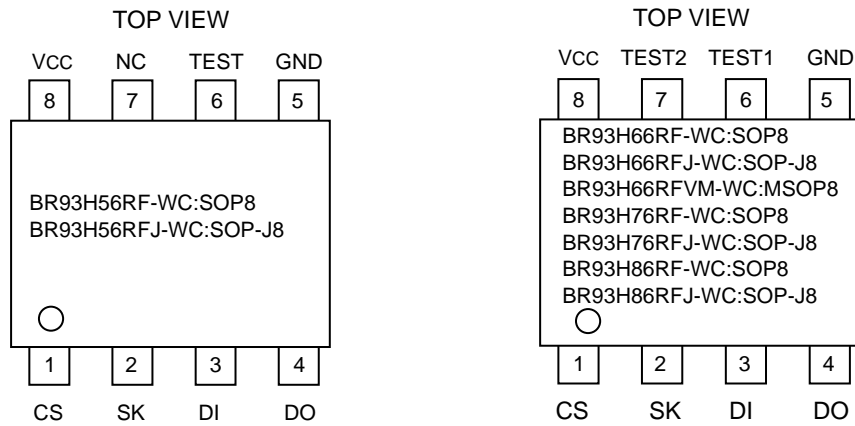

●Pin Descriptions

Pin name	I / O	Function
Vcc	-	Power source
GND	-	All input / output reference voltage, 0V
CS	Input	Chip select input
SK	Input	Serial clock input
DI	Input	Start bit, ope code, address, and serial data input
DO	Output	Serial data output, READY / $\overline{\text{BUSY}}$ internal condition display output
NC	-	Non connected terminal, Vcc, GND or OPEN
TEST1	-	TEST terminal, GND or OPEN
TEST2	-	TEST terminal, Vcc, GND or OPEN
TEST	-	TEST terminal, GND or OPEN

● Typical Performance Curves

(The following characteristic data are Typ. values.)

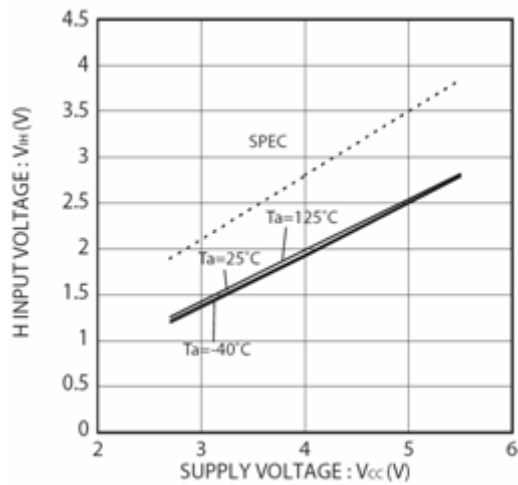

Figure 1. H input voltage V_{IH} (CS, SK, DI)

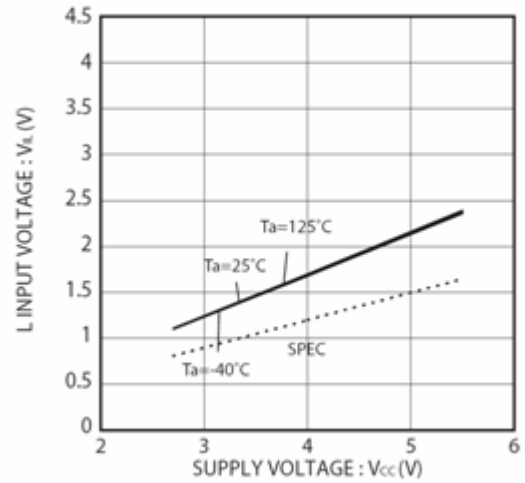

Figure 2. L input voltage V_{IL} (CS, SK, DI)

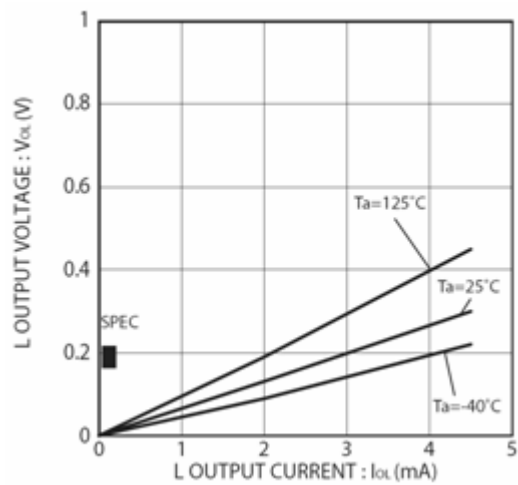

Figure 3. L output voltage V_{OL} - I_{OL} ($V_{CC}=2.7$)

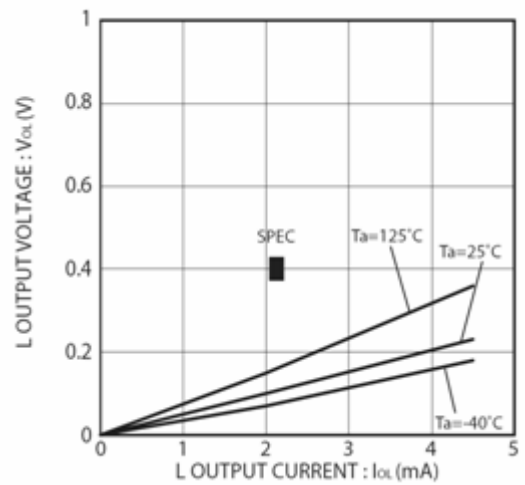

Figure 4. L output voltage V_{OL} - I_{OL} ($V_{CC}=4.0$)

● Typical Performance Curves - Continued

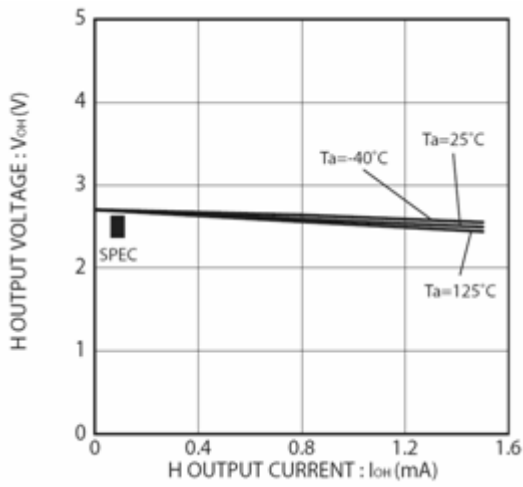

Figure 5. H output voltage V_{OH} - I_{OH} ($V_{CC}=2.7$)

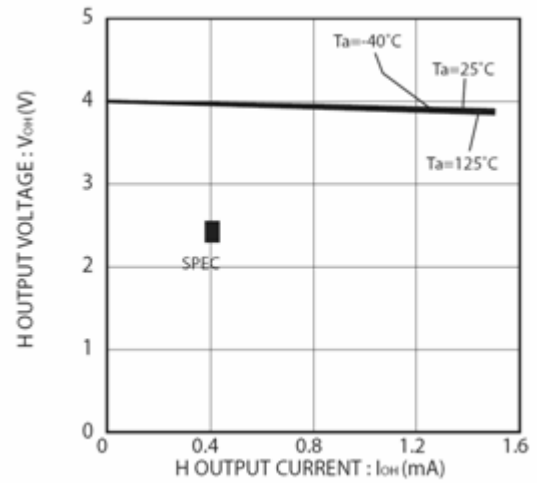

Figure 6. H output voltage V_{OH} - I_{OH} ($V_{CC}=4.0V$)

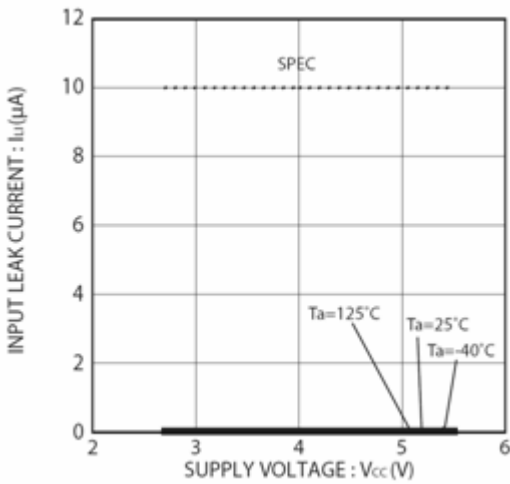

Figure 7. Input leak current I_{II} (CS, SK, DI)

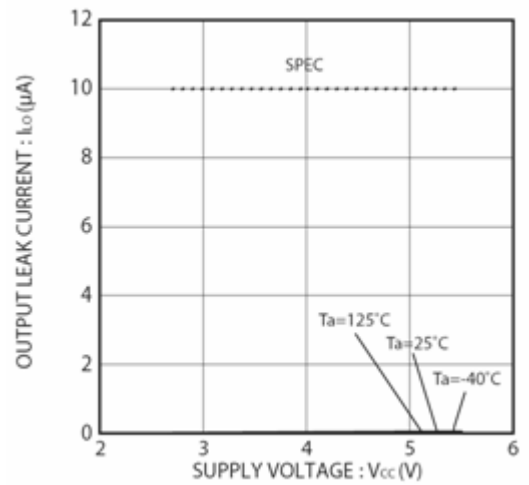

Figure 8. Output leak current I_{LO} (DO)

● Typical Performance Curves - Continued

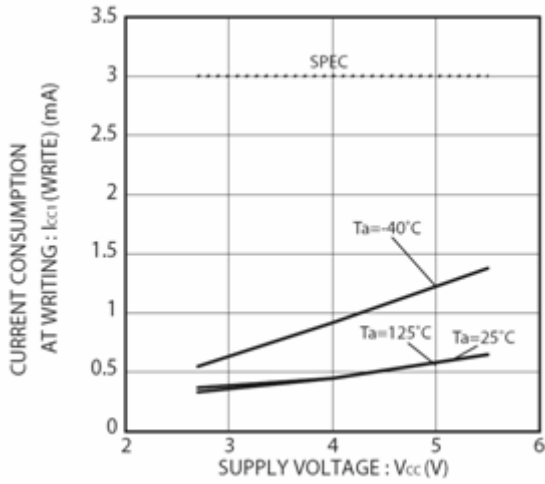

Figure 9. Current consumption at WRITE Operation ICC1 (WRITE, fSK=1.25MHz)

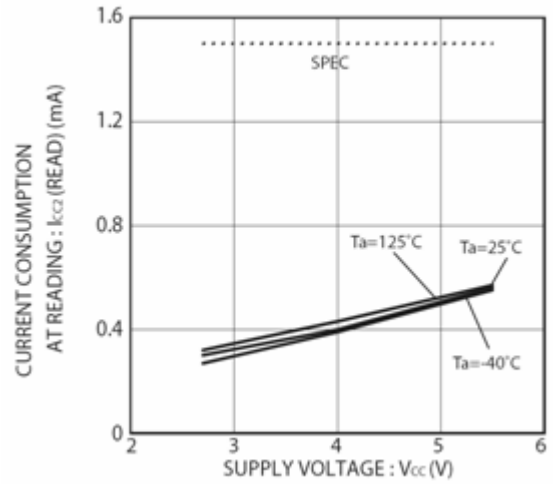

Figure 10. Consumption current at READ Operation ICC2 (READ, fSK=1.25MHz)

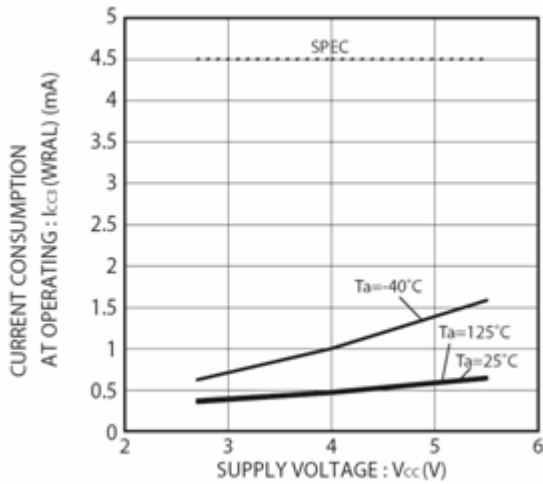

Figure 11. Consumption current at WRAL operation ICC3 (WRAL, fSK=1.25MHz)

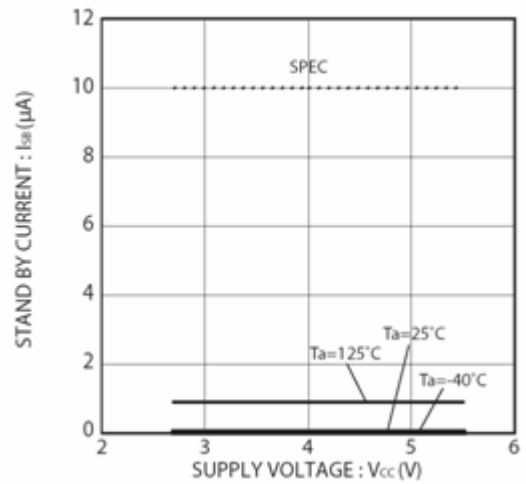

Figure 12. Consumption current at standby condition ISB

● Typical Performance Curves - Continued

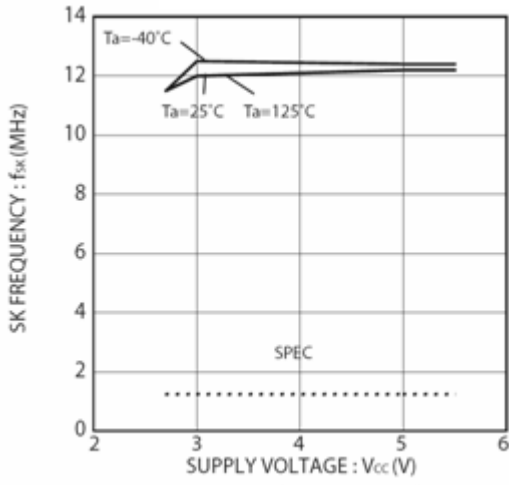

Figure 13. SK frequency fSK

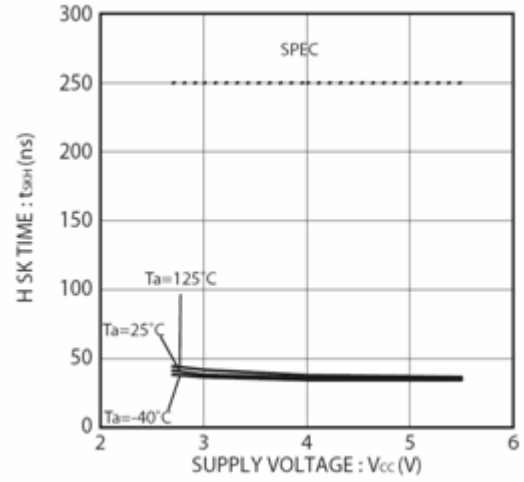

Figure 14. SK high time tSKH

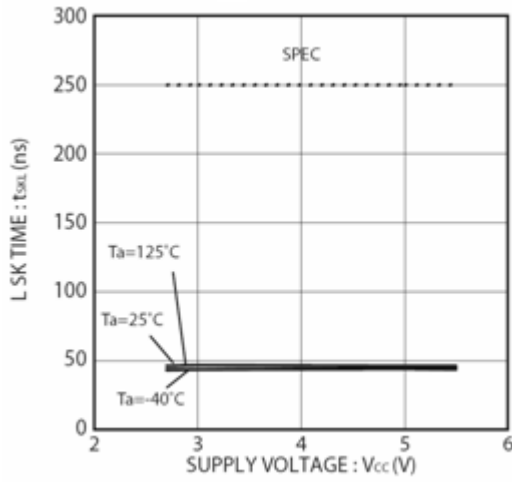

Figure 15. SK low time tSKL

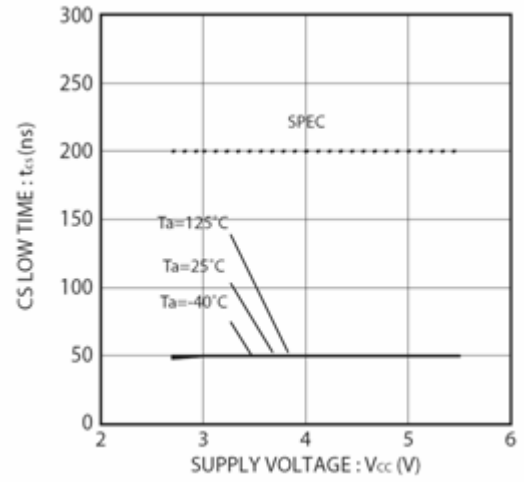

Figure 16. CS low time tCS

● Typical Performance Curves - Continued

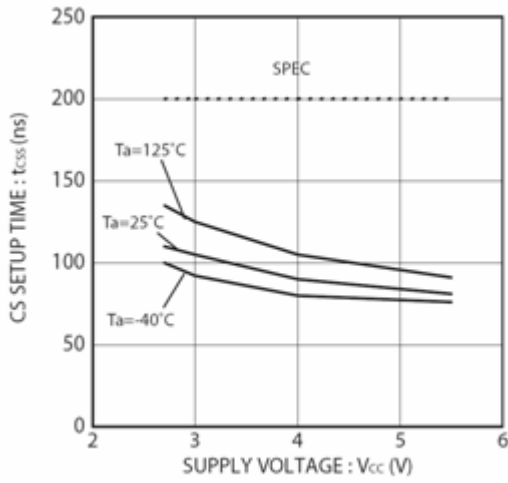

Figure 17. CS setup time tCSS

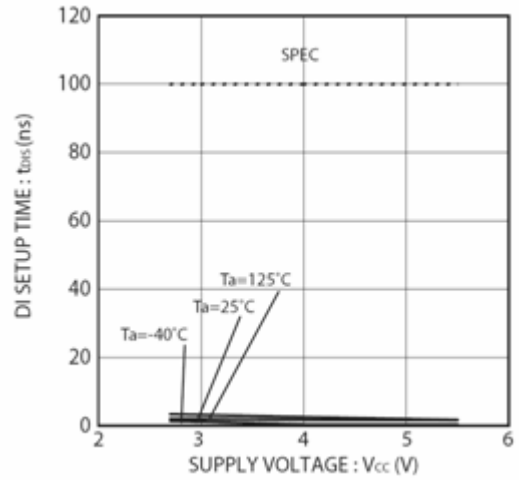

Figure 18. DI setup time tDIS

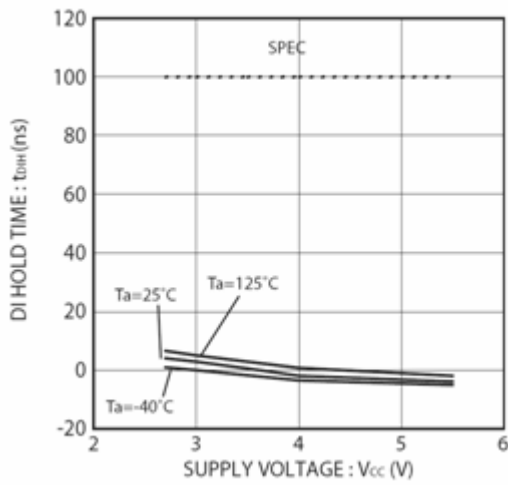

Figure 19. DI hold time tDIH

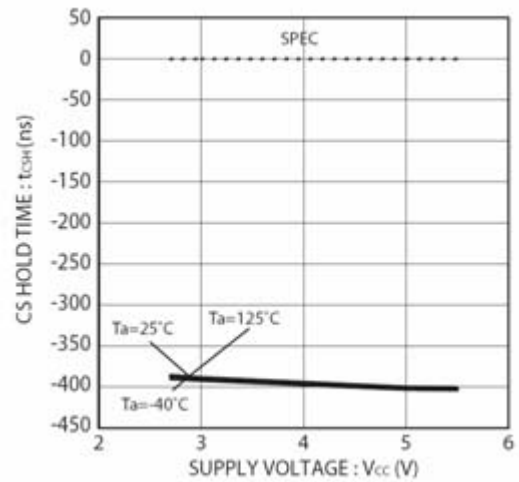
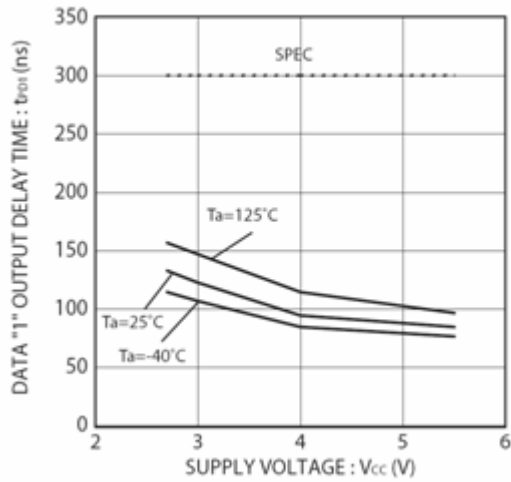
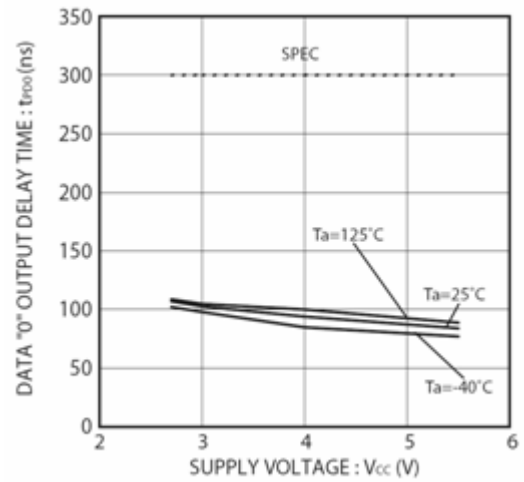
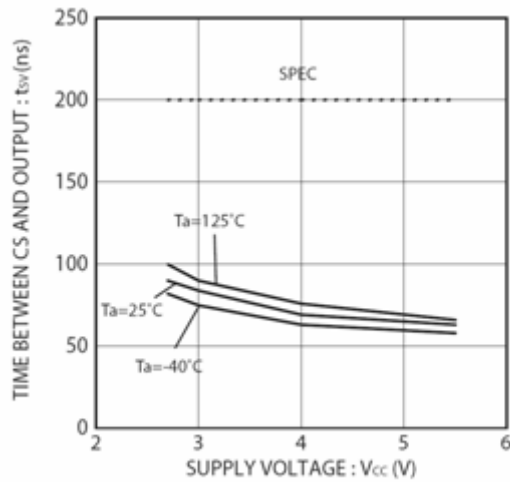
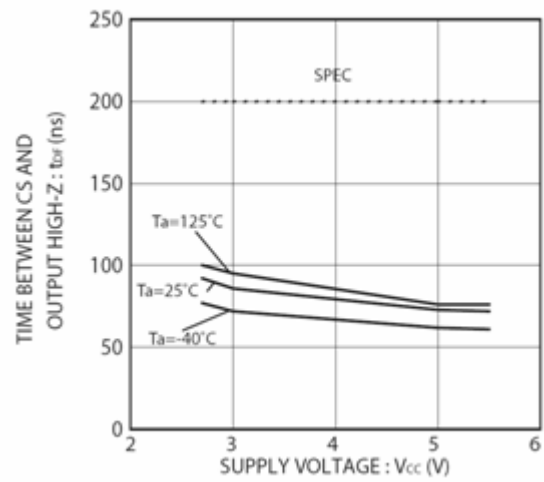

Figure 20. CS hold time tCSH

● Typical Performance Curves - Continued

Figure 21. Data "1" output delay time t_{PD1} Figure 22. Data "0" output delay time t_{PD0} Figure 23. Time from CS to output establishment t_{SV} Figure 24. Time from CS to High-Z t_{DF}

● Typical Performance Curves - Continued

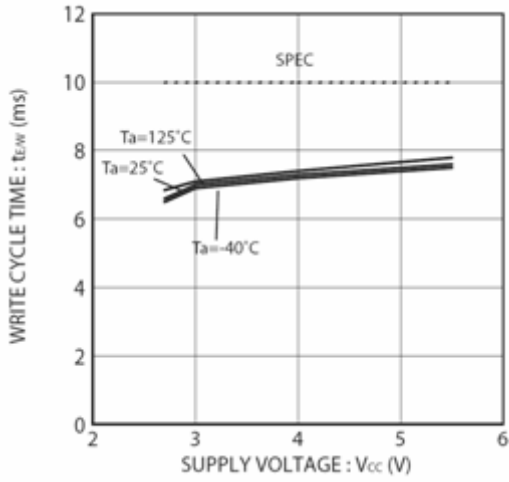

Figure 25. Write cycle time tE/W

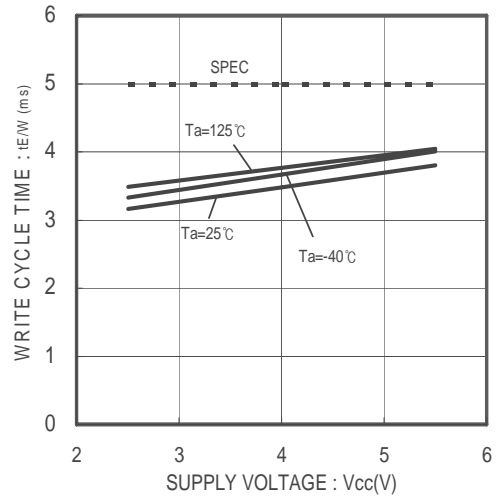

Figure 26. Write cycle time tE/W (BR93H66RFVM-WC)

●Description of Operations

Communications of the Microwire Bus are carried out by SK (serial clock), DI (serial data input), DO (serial data output), and CS (chip select) for device selection.

When to connect one EEPROM to a microcontroller, connect it as shown in Figure 27-(a) or Figure 27-(b). When to use the input and output common I/O port of the microcontroller, connect DI and DO via a resistor as shown in Figure 27-(b) (Refer to page 16.), and connection by 3 lines is available.

In the case of plural connections, refer to Figure 27-(c).

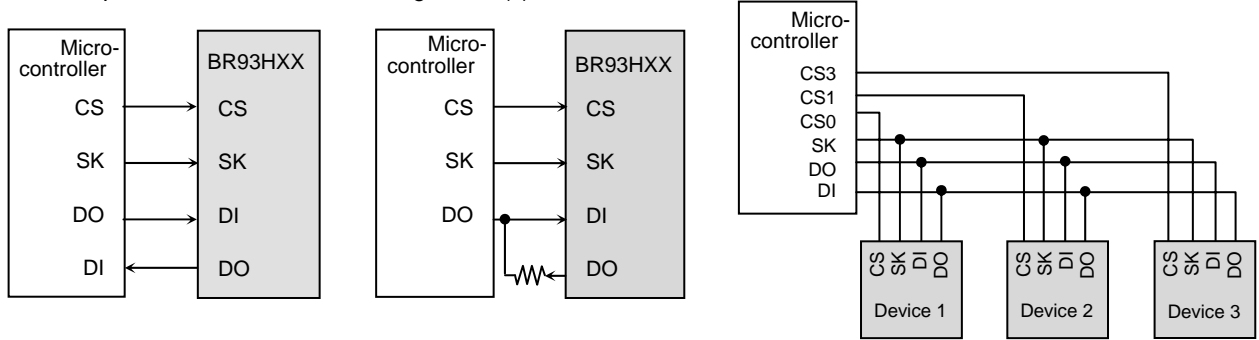

Figure 27-(a) Connection by 4 lines

Figure 27-(b) Connection by 3 lines

Figure 27-(c) Connection example of plural devices

Figure 27. Connection method with microcontroller

Communications of the Microwire Bus are started by the first “1” input after the rise of CS. This input is called a start bit. After input of the start bit, input ope code, address and data. Address and data are input all in MSB first manners.

“0” input after the rise of CS to the start bit input is all ignored. Therefore, when there is limitation in the bit width of PIO of the microcontroller, input “0” before the start bit input, to control the bit width.

●Command Mode

Command	Start bit	Ope code	Address		Data
			BR93H56/66-WC	BR93H76/86-WC	
Read (READ) ^{*1}	1	10	A7,A6,A5,A4,A3,A2,A1,A0	A9,A8,A7,A6,A5,A4,A3,A2,A1,A0	D15 to D0(READ DATA)
Write enable (WEN)	1	00	1 1 * * * * *	1 1 * * * * * *	
Write (WRITE) ^{*2}	1	01	A7,A6,A5,A4,A3,A2,A1,A0	A9,A8,A7,A6,A5,A4,A3,A2,A1,A0	D15 to D0(WRITE DATA)
Write all (WRAL) ^{*2,3}	1	00	0 1 * * * * * B0	0 1 * * * * * B2,B1,B0	D15 to D0(WRITE DATA)
Write disable (WDS)	1	00	0 0 * * * * * *	0 0 * * * * * *	

- Input the address and the data in MSB first manners.
- As for *, input either VIH or VIL.

A7 and B0 of BR93H56-WC becomes Don't Care.
A9 and B2 of BR93H76-WC becomes Don't Care.

*Start bit
Acceptance of all the commands of this IC starts at recognition of the start bit.
The start bit means the first “1” input after the rise of CS.

*1 As for read, by continuous SK clock input after setting the read command, data output of the set address starts, and address data in significant order are sequentially output continuously. (Auto increment function)

*2 When the read and the write all commands are executed, data written in the selected memory cell is automatically deleted, and input data is written.

*3 For the write all command, data written in memory cell of the areas designated by B2, B1, and B0, are automatically deleted, and input data is written in bulk.

●Write All Area

B2	B1	B0	Write area
0	0	0	000h to 07Fh
0	0	1	080h to 0FFh
0	1	0	100h to 17Fh
0	1	1	180h to 1FFh
1	0	0	200h to 27Fh
1	0	1	280h to 2FFh
1	1	0	300h to 37Fh
1	1	1	380h to 3FFh

Designation of B2, B1, and B0

Address	B2	B1	B0
H56	*	*	*
H66	*	*	B0
H76	*	B1	B0
H86	B2	B1	B0

- The write all command is written in bulk in 2Kbit unit.

The write area can be selected up to 3bit. Confirm the settings and write areas of the above B2, B1, and B0.

●Timing Chart

1) Read cycle (READ)

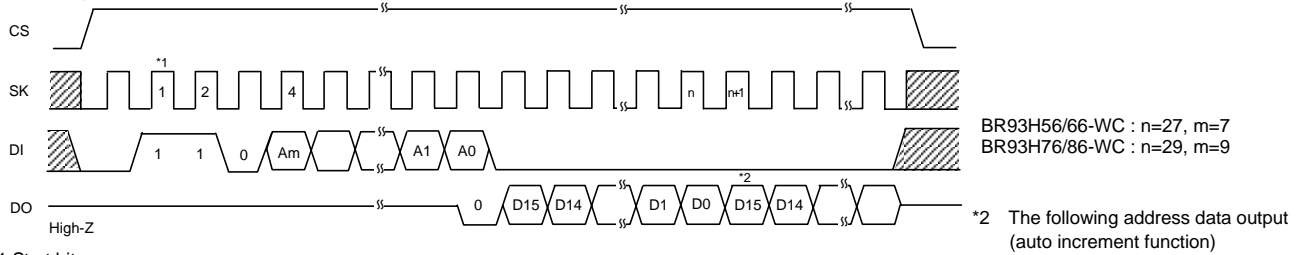

Figure 28. Read cycle

○When the read command is recognized, input address data (16bit) is output to serial. And at that moment, at taking A0, in sync with the rise of SK, "0" (dummy bit) is output. And, the following data is output in sync with the rise of SK. This IC has address auto increment function valid only at read command. This is the function where after the above read execution, by continuously inputting SK clock, the above address data is read sequentially. And, during the auto increment, keep CS at "H".

2) Write cycle (WRITE)

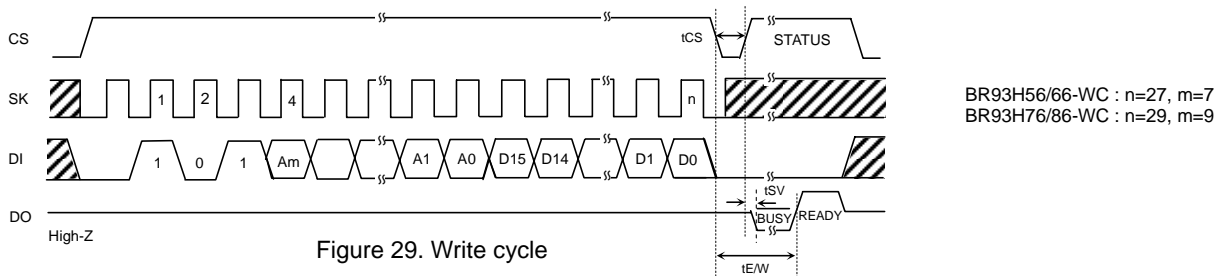

Figure 29. Write cycle

○In this command, input 16bit data (D15 to D0) are written to designated addresses (Am to A0). The actual write starts by the fall of CS of D0 taken SK clock(n-th clock from the start bit input), to the rise of the (n+1)-th clock. When STATUS is not detected, (CS="L" fixed) Max. 10ms(Max.5ms:BR93H66RFVM-WC) in conformity with tE/W, and when STATUS is detected (CS="H"), all commands are not accepted for areas where "L" (BUSY) is output from DO, therefore, do not input any command. Write is not made even if CS is started after input of clock after (n+1)-th clocks. Note) Take tSKH or more from the rise of the n-th clock to the fall of CS.

3) Write all cycle (WRAL)

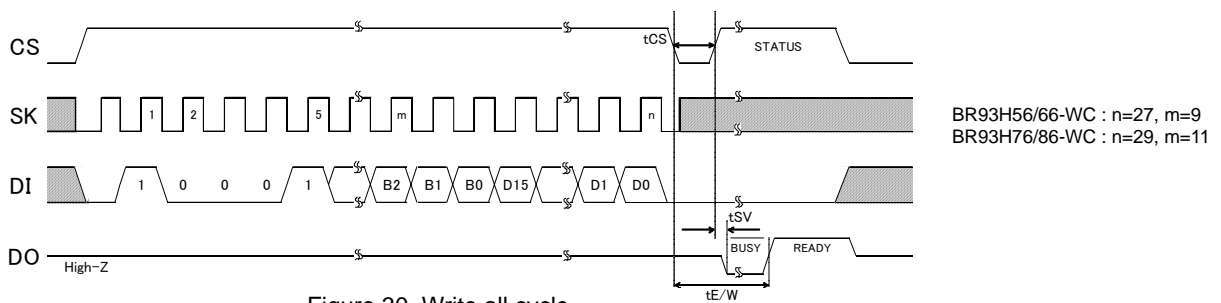

Figure 30. Write all cycle

○In this command, input 16bit data is written simultaneously to designated block for 128 words. Data is written in bulk at a write time of only Max. 10ms(Max.5ms:BR93H66RFVM-WC) in conformity with tE/W. When writing data to all addresses, designate each block by B2, B1, and B0, and execute write. Write time is Max.10ms(Max.5ms:BR93H66RFVM-WC). The actual write starts by the fall of CS from the rise of D0 taken at SK clock (n-th clock from the start bit input), to the rise of the (n+1)-th clock. When CS is ended after clock input after the rise of the (n+1)-th clock, command is cancelled, and write is not completed. Note)Take tSKH or more from the rise of the n-th clock to the fall of CS.

4) Write enable (WEN) / disable (WDS) cycle

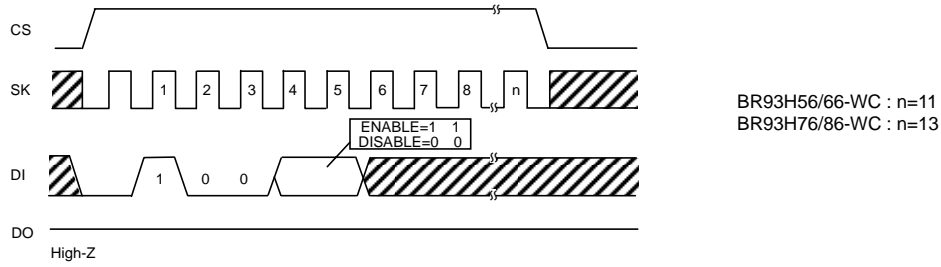

Figure 31. Write enable (WEN) / disable (WDS) cycle

○At power on, this IC is in write disable status by the internal RESET circuit. Before executing the write command, it is necessary to execute the write enable command. And, once this command is executed, it is valid until the write disable command is executed or the power is turned off. However, the read command is valid irrespective of write enable / disable command. Input to SK after 6 clocks of this command is available by either "H" or "L", but be sure to input it.

○When the write enable command is executed after power on, write enable status gets in. When the write disable command is executed then, the IC gets in write disable status as same as at power on, and then the write command is cancelled thereafter in software manner. However, the read command is executable. In write enable status, even when the write command is input by mistake, write is started. To prevent such a mistake, it is recommended to execute the write disable command after completion of write.

●Application

1) Method to cancel each command

OREAD

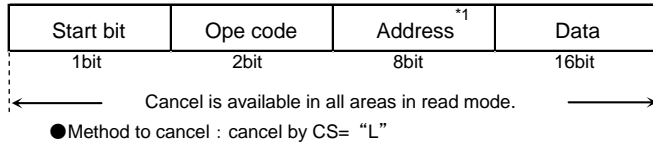

*1 Address is 8 bits in BR93H56-WC, and BR93H66-WC. Address is 10 bits in BR93H76-WC, and BR93H86-WC.

Figure 32. READ cancel available timing

OWRITE, WRAL

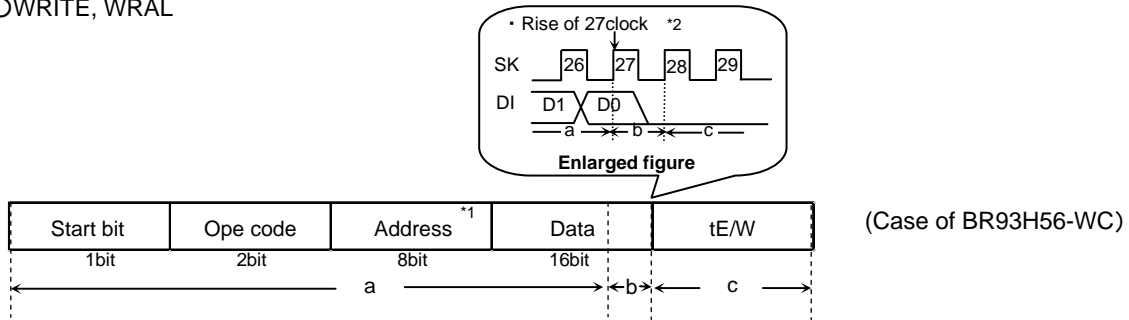

- a : From start bit to 27 clock rise
Cancel by CS="L"
- b : 27 clock rise and after *2
Cancellation is not available by any means. If Vcc is made OFF in this area, designated address data is not guaranteed, therefore write once again.
- c : 28 clock rise and after *3
Cancel by CS="L"
However, when write is started in b area (CS is ended), cancellation is not available by any means.
And when SK clock is input continuously, cancellation is not available.

- *1 Address is 8 bits in BR93H56/66-WC
Address is 10 bits in BR93H76/86-WC
- *2 27 clocks in BR93H56/66-WC
29 clocks in BR93H76/86-WC
- *3 28 clocks in BR93H56/66-WC
30 clocks in BR93H76/86-WC

Note 1) If Vcc is made OFF in this area, designated address data is not guaranteed, therefore write once again.

Note 2) If CS is started at the same timing as that of the SK rise, write execution/cancel becomes unstable, therefore, it is recommended to fail in SK="L" area. As for SK rise, recommend timing of tCSS/tCSH or higher.

Figure 33. WRITE, WRAL cancel available timing

2) Equivalent circuit
 ○Output circuit

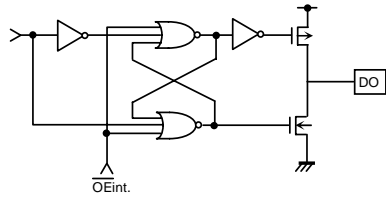

Figure 34. Output circuit (DO)

○ Input circuit

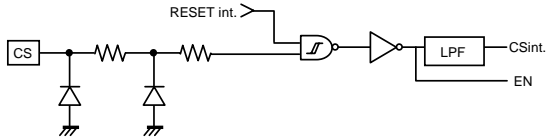

Figure 35. Input circuit (CS)

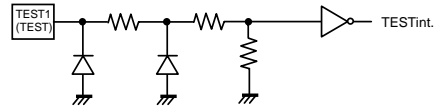

Figure 36. Input circuit (TEST1, TEST)

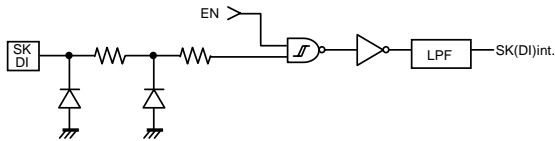

Figure 37. Input circuit (SK, DI)



Figure 38. Input circuit (TEST2)

3) I/O peripheral circuit

3-1) Pull down CS.

By making CS="L" at power ON/OFF, mistake in operation and mistake write are prevented. Refer to the item 6) Notes at power ON/OFF in page 20.

○Pull down resistance Rpd of CS pin

To prevent mistake in operation and mistake write at power ON/OFF, CS pull down resistance is necessary. Select an appropriate value to this resistance value from microcontroller VOH, IOH, and VIL characteristics of this IC.

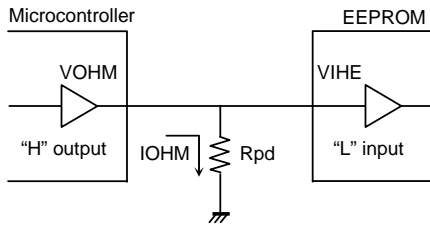

Figure 39. CS pull down resistance

$$R_{pd} \geq \frac{VO_{HM}}{IO_{HM}} \quad \dots \textcircled{1}$$

$$VO_{HM} \geq VI_{HE} \quad \dots \textcircled{2}$$

Example) When $V_{CC} = 5V$, $VI_{HE} = 2V$, $VO_{HM} = 2.4V$, $IO_{HM} = 2mA$, from the equation ①,

$$R_{pd} \geq \frac{2.4}{2 \times 10^{-3}}$$

$$\therefore R_{pd} \geq 1.2 [k\Omega]$$

With the value of Rpd to satisfy the above equation, VOHM becomes 2.4V or higher, and VIHE (=2.0V), the equation ② is also satisfied.

- VIHE : EEPROM VIH specifications
- VOHM : Microcontroller VOH specifications
- IOHM :Microcontroller IOH specifications

3-2) DO is available in both pull up and pull down.

DO output become "High-Z" in other READY / BUSY output timing than after data output at read command and write command. When malfunction occurs at "High-Z" input of the microcontroller port connected to DO, it is necessary to pull down and pull up DO. When there is no influence upon the microcontroller operations, DO may be OPEN. If DO is OPEN, and at timing to output status READY, at timing of CS="H", SK="H", DI="H", EEPROM recognizes this as a start bit, resets READY output, and DO="High-Z", therefore, READY signal cannot be detected. To avoid such output, pull up DO pin for improvement.

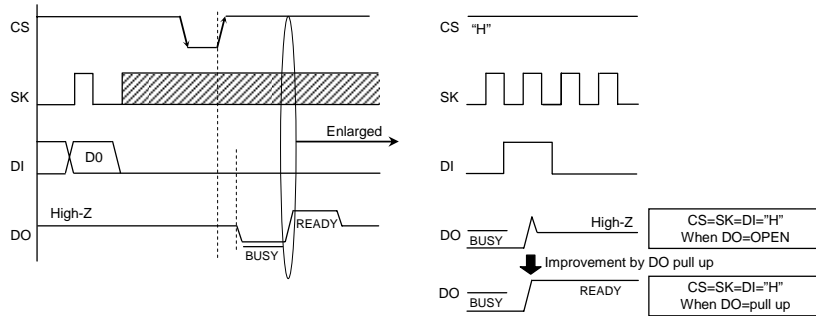

Figure 40. READY output timing at DO=OPEN

OPull up resistance Rpu and pull down resistance Rpd of DO pin

As for pull up and pull down resistance value, select an appropriate value to this resistance value from microcontroller VIH, VIL, and VOH, IOH, VOL, IOL characteristics of this IC.

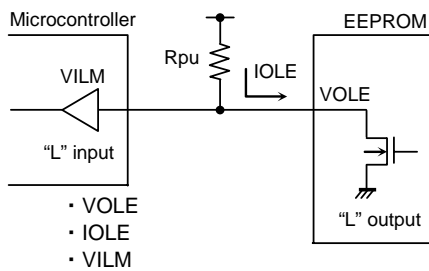

Figure 41. DO pull up resistance

$$R_{pu} \geq \frac{V_{CC} - V_{OLE}}{I_{OLE}} \quad \dots \textcircled{3}$$

$$V_{OLE} \leq V_{ILM} \quad \dots \textcircled{4}$$

Example) When $V_{CC} = 5V$, $V_{OLE} = 0.4V$, $I_{OLE} = 2.1mA$, $V_{ILM} = 0.8V$, from the equation $\textcircled{3}$,

$$R_{pu} \geq \frac{5 - 0.4}{2.1 \times 10^{-3}}$$

$$\therefore R_{pu} \geq 2.2 [k\Omega]$$

With the value of Rpu to satisfy the above equation, VOLE becomes 0.4V or below, and with VILM(=0.8V), the equation $\textcircled{4}$ is also satisfied.

- VOLE : EEPROM VOL specifications
- IOLE : EEPROM IOL specifications
- VILM : Microcontroller VIL specifications

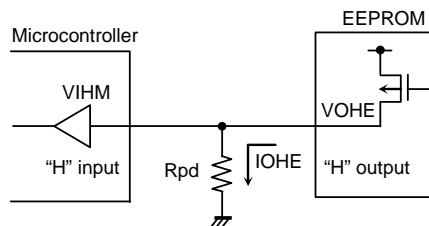

Figure 42. DO pull down resistance

$$R_{pd} \geq \frac{V_{OHE}}{I_{OHE}} \quad \dots \textcircled{5}$$

$$V_{OHE} \geq V_{IH} \quad \dots \textcircled{6}$$

Example) When $V_{CC} = 5V$, $V_{OHE} = V_{CC} - 0.2V$, $I_{OHE} = 0.1mA$, $V_{IH} = V_{CC} \times 0.7V$ from the equation $\textcircled{5}$

$$R_{pd} \geq \frac{5 - 0.2}{0.1 \times 10^{-3}}$$

$$\therefore R_{pd} \geq 48 [k\Omega]$$

With the value of Rpd to satisfy the above equation, VOHE becomes 2.4V or below, and with VIH(=3.5V), the equation $\textcircled{6}$ is also satisfied.

- VOHE : EEPROM VOH specifications
- IOHE : EEPROM IOH specifications
- VIH : Microcontroller VIH specifications

OREADY / $\overline{\text{BUSY}}$ status display (DO terminal)

(common to BR93H56-WC, BR93H66-WC, BR93H76-WC, BR93H86-WC)

This display outputs the internal status signal. When CS is started after tCS (Min.200ns) from CS fall after write command input, "H" or "L" output.

R/B display="L" ($\overline{\text{BUSY}}$) = write under execution

(DO status)

After the timer circuit in the IC works and creates the period of tE/W, this time circuit completes automatically. And write to the memory cell is made in the period of tE/W, and during this period, other command is not accepted.

R/B display = "H" (READY) = command wait status

(DO status)

Even after tE/W (max.10ms) (Max.5ms:BR93H66RFVM-WC) from write of the memory cell, the following command is accepted.

Therefore, CS="H" in the period of tE/W, and when input is in SK, DI, malfunction may occur, therefore, DI="L" in the area CS="H". (Especially, in the case of shared input port, attention is required.)

*Do not input any command while status signal is output. Command input in $\overline{\text{BUSY}}$ area is cancelled, but command input in READY area is accepted. Therefore, status READY output is cancelled, and malfunction and mistake write may be made.

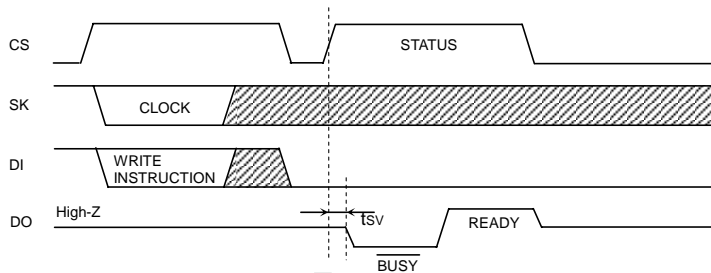

Figure 43. R/B status output timing chart

4) When to directly connect DI and DO

This IC has independent input terminal DI and output terminal DO, and separate signals are handled on timing chart, meanwhile, by inserting a resistance R between these DI and DO terminals, it is possible to carry out control by 1 control line.

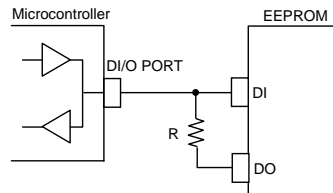

Figure 44. DI, DO control line common connection

OData collision of microcontroller DI/O output and DO output and feedback of DO output to DI input.

Drive from the microcontroller DI/O output to DI input on I/O timing, and signal output from DO output occur at the same time in the following points.

4-1) 1 clock cycle to take in A0 address data at read command

Dummy bit "0" is output to DO terminal.

→When address data A0 = "1" input, through current route occurs.

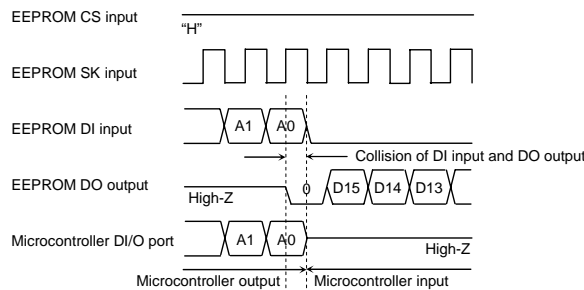

Figure 45. Collision timing at read data output at DI, DO direct connection

- 4-2) Timing of CS = "H" after write command. DO terminal in READY / BUSY function output.
 When the next start bit input is recognized, "HIGH-Z" gets in.
 →Especially, at command input after write, when CS input is started with microcontroller DI/O output "L",
 READY output "H" is output from DO terminal, and through current route occurs.

Feedback input at timing of these 4-1) and 4-2) does not cause disorder in basic operations, if resistance R is inserted.

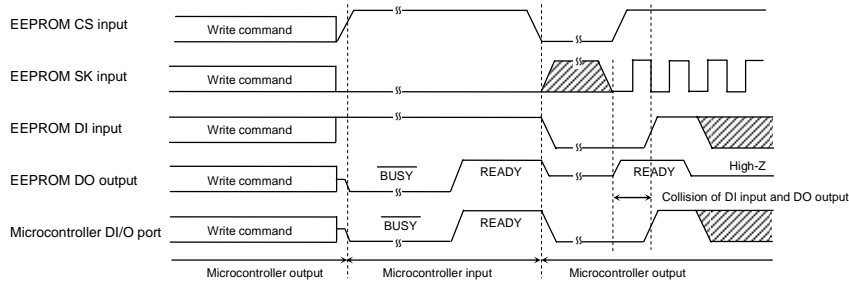
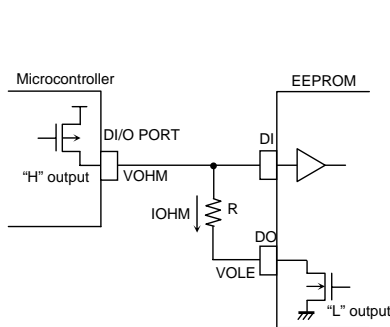

Figure 46. Collision timing at DI, DO direct connection

OSelection of resistance value R

The resistance R becomes through current limit resistance at data collision. When through current flows, noises of power source line and instantaneous stop of power source may occur. When allowable through current is defined as I, the following relation should be satisfied. Determine allowable current amount in consideration of impedance and so forth of power source line in set. And insert resistance R, and set the value R to satisfy EEPROM input level VIH/VIL, even under influence of voltage decline owing to leak current and so forth. Insertion of R will not cause any influence upon basic operations.

- 4-3) Address data A0 = "1" input, dummy bit "0" output timing
 (When microcontroller DI/O output is "H", EEPROM DO outputs "L", and "H" is input to DI)
- Make the through current to EEPROM 10mA or below.
 - See to it that the input level VIH of EEPROM should satisfy the following.



Conditions

$$VO_{HM} \leq VI_{HE}$$

$$VO_{HM} \leq IO_{HM} \times R + VO_{LE}$$

At this moment, if $VO_{LE}=0V$,

$$VO_{HM} \leq IO_{HM} \times R$$

$$\therefore R \geq \frac{VO_{HM}}{IO_{HM}} \quad \dots \textcircled{7}$$

- VI_{HE} : EEPROM VIH specifications
- VO_{LE} : EEPROM VOL specifications
- VO_{HM} : Microcontroller VOH specifications
- IO_{HM} : Microcontroller IOH specifications

Figure 47. Circuit at DI, DO direct connection (Microcontroller DI/O "H" output, EEPROM "L" output)

4-4) DO status READY output timing

(When the microcontroller DI/O is "L", EEPROM DO outputs "H", and "L" is input to DI)

- Set the EEPROM input level VIL so as to satisfy the following.

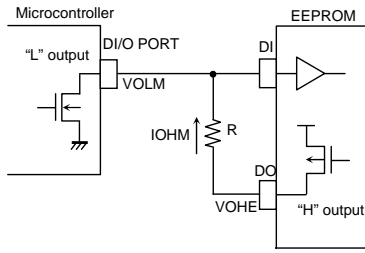

Conditions

$$VOLM \geq VILE$$

$$VOLM \geq VOHE - IOLM \times R$$

As this moment, if VOHE=Vcc,

$$VOLM \geq Vcc - IOLM \times R$$

$$\therefore R \geq \frac{Vcc - VOLM}{IOLM} \dots \textcircled{8}$$

- VILE : EEPROM VIL specifications
- VOHE : EEPROM VOH specifications
- VOLM : Microcontroller VOL specifications
- IOLM : Microcontroller IOL specifications

Example) When Vcc=5V, VOHE=5V, IOHM=0.4mA, VOLM=5V, IOLM=0.4mA,

From the equation ⑦,

$$R \geq \frac{VOHM}{IOHM}$$

$$R \geq \frac{5}{0.4 \times 10^{-3}}$$

$$\therefore R \geq 12.5 [k\Omega] \dots \textcircled{9}$$

From the equation ⑧,

$$R \geq \frac{Vcc - VOLM}{IOLM}$$

$$R \geq \frac{5 - 0.4}{2.1 \times 10^{-3}}$$

$$\therefore R \geq 2.2 [k\Omega] \dots \textcircled{10}$$

Therefore, from the equations ⑨ and ⑩,

$$\therefore R \geq 12.5 [k\Omega]$$

Figure 48. Circuit at DI, DO direct connection (Microcontroller DI/O "L" output, EEPROM "H" output)

5) Notes at test pin wrong input

There is no influence of external input upon TEST2 pin.

For TEST1 (TEST)pin, input must be GND or OPEN. If H level is input, the following may occur,

1. At WEN, WDS, READ command input
There is no influence by TEST1 (TEST) pin.
2. WRITE, WRAL command input

* BR93H56-WC, BR93H66-WC, address 8 bits
BR93H76-WC, BR93H86-WC, address 10 bits

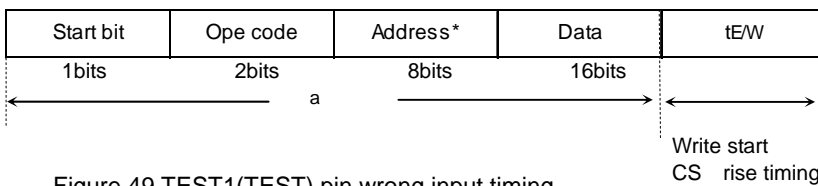

Figure 49. TEST1 (TEST) pin wrong input timing

a : There is no influence by TEST1 (TEST) pin.

b : If H during write execution, it may not be written correctly. And H area remains \overline{BUSY} and READY does not go back. Avoid noise input, and at use, be sure to connect it to GND terminal or set it OPEN.

6) Notes on power ON/OFF

- At power ON/OFF, set CS "L".

When CS is "H", this IC gets in input accept status (active). At power ON, set CS "L" to prevent malfunction from noise. (When CS is in "L" status, all inputs are cancelled.) At power decline low power status may prevail. Therefore, at power OFF, set CS "L" to prevent malfunction from noise.

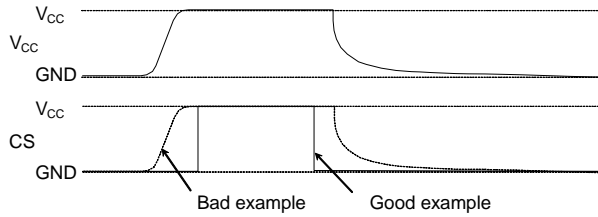

Figure 50. Timing at power ON/OFF

(Bad example) CS pin is pulled up to Vcc.

In this case, CS becomes "H" (active status), EEPROM may malfunction or have write error due to noises. This is true even when CS input is High-Z.

(Good example) It is "L" at power ON/OFF.

Set 10ms or higher to recharge at power OFF. When power is turned on without observing this condition, IC internal circuit may not be reset.

OPOR circuit

This IC has a POR (Power On Reset) circuit as a mistake write countermeasure. After POR operation, it gets in write disable status. The POR circuit is valid only when power is ON, and does not work when power is OFF. However, if CS is "H" at power ON/OFF, it may become write enable status owing to noises and the likes. For secure operation, observe the following conditions.

- Set CS="L"
- Turn on power so as to satisfy the recommended conditions of t_R , t_{OFF} , V_{bot} for POR circuit operation.

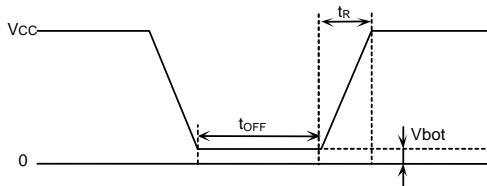

Recommended conditions of t_R , t_{OFF} , V_{bot}

t_R	t_{OFF}	V_{bot}
10ms or below	10ms or higher	0.3V or below
100ms or below	10ms or higher	0.2V or below

Figure 51. Rise waveform diagram

OLVCC circuit

LVCC (Vcc-Lockout) circuit prevents data rewrite operation at low power, and prevents wrong write. At LVCC voltage (Typ.=1.9V) or below, it prevent data rewrite.

7) Noise countermeasures

OVcc noise (bypass capacitor)

When noise or surge gets in the power source line, malfunction may occur, therefore, for removing these, it is recommended to attach a by pass capacitor (0.1 μ F) between IC Vcc and GND, At that moment, attach it as close to IC as possible. And, it is also recommended to attach a bypass capacitor between board Vcc and GND.

OSK noise

When the rise time (t_R) of SK is long, and a certain degree or more of noise exists, malfunction may occur owing to clock bit displacement.

To avoid this, a Schmitt trigger circuit is built in SK input. The hysteresis width of this circuit is set about 0.3, if noises exist at SK input, set the noise amplitude 0.3p-p or below. And it is recommended to set the rise time (t_R) of SK 100ns or below. In the case when the rise time is 100ns or higher, take sufficient noise countermeasures. Make the clock rise, fall time as small as possible.

●Cautions on Use

- (1) Described numeric values and data are design representative values, and the values are not guaranteed.
- (2) We believe that application circuit examples are recommendable, however, in actual use, confirm characteristics further sufficiently. In the case of use by changing the fixed number of external parts, make your decision with sufficient margin in consideration of static characteristics and transition characteristics and fluctuations of external parts and our IC.
- (3) Absolute Maximum Ratings
If the absolute maximum ratings such as impressed voltage and operating temperature range and so forth are exceeded, IC may be destructed. Do not impress voltage and temperature exceeding the absolute maximum ratings. In the case of fear exceeding the absolute maximum ratings, take physical safety countermeasures such as fuses, and see to it that conditions exceeding the absolute maximum ratings should not be impressed to IC.
- (4) GND electric potential
Set the voltage of GND terminal lowest at any operating condition. Make sure that each terminal voltage is not lower than that of GND terminal in consideration of transition status.
- (5) Heat design
In consideration of allowable loss in actual use condition, carry out heat design with sufficient margin.
- (6) Terminal to terminal shortcircuit and wrong packaging
When to package IC onto a board, pay sufficient attention to IC direction and displacement. Wrong packaging may destruct IC. And in the case of shortcircuit between IC terminals and terminals and power source, terminal and GND owing to foreign matter, IC may be destructed.
- (7) Use in a strong electromagnetic field may cause malfunction, therefore, evaluate design sufficiently.

● Ordering Information

Product Code Description

B	R	9	3	H	x	x	x	x	x	-	W	C	x	x
---	---	---	---	---	---	---	---	---	---	---	---	---	---	---

BUS Type

93 : Microwire

Operating temperature

-40°C to +125°C

Capacity

56=2K

76=8K

66=4K

86=16K

Package type

RF : SOP8

RFJ : SOP-J8

RFVM : MSOP8

W : Double cell

C : For Automotive Application

Package specifications

E2 : Embossed tape and reel (SOP8, SOP-J8)

TR : Embossed tape and reel (MSOP8)

● Lineup

Capacity	Package	
	Type	Quantity
2K	SOP8	Reel of 2500
	SOP-J8	
4K	SOP8	Reel of 2500
	SOP-J8	
	MSOP8	Reel of 3000
8K	SOP8	Reel of 2500
	SOP-J8	
16K	SOP8	Reel of 2500
	SOP-J8	

●Physical Dimension Tape and Reel Information

SOP8

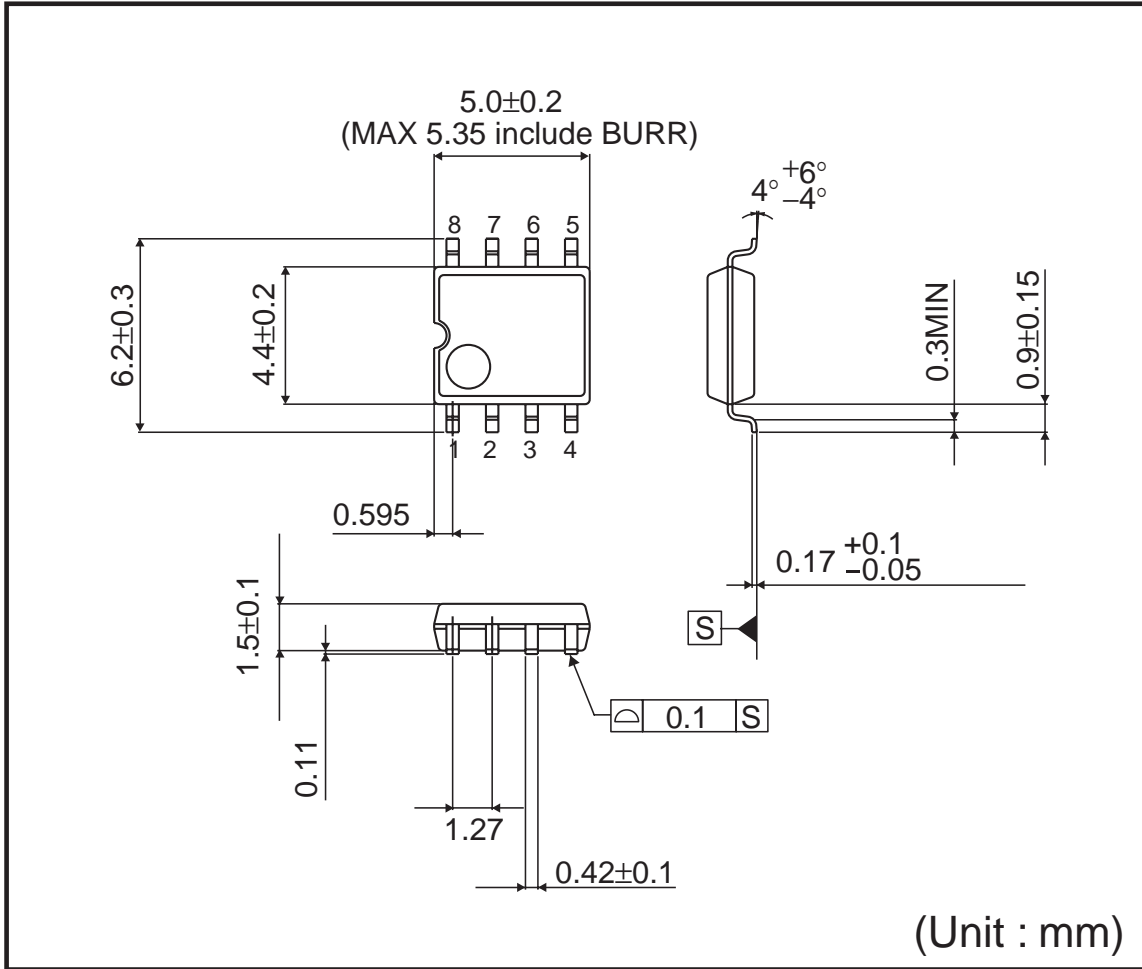

<Tape and Reel information>

Tape	Embossed carrier tape
Quantity	2500pcs
Direction of feed	E2 (The direction is the 1pin of product is at the upper left when you hold reel on the left hand and you pull out the tape on the right hand)

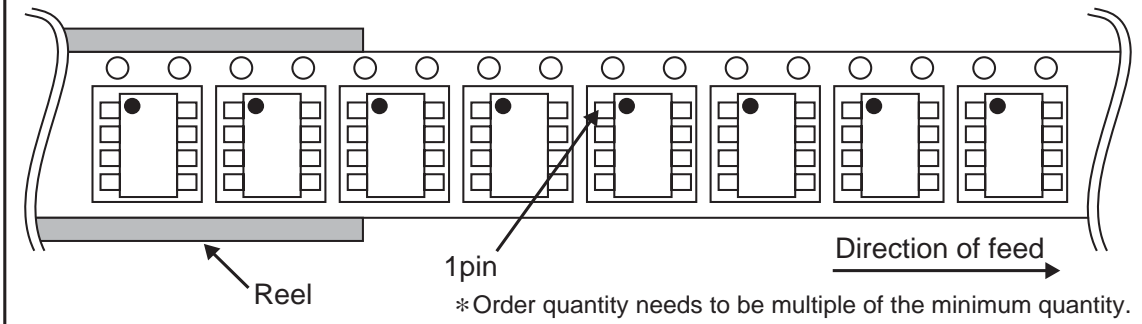

●Physical Dimension Tape and Reel Information - Continued

SOP-J8

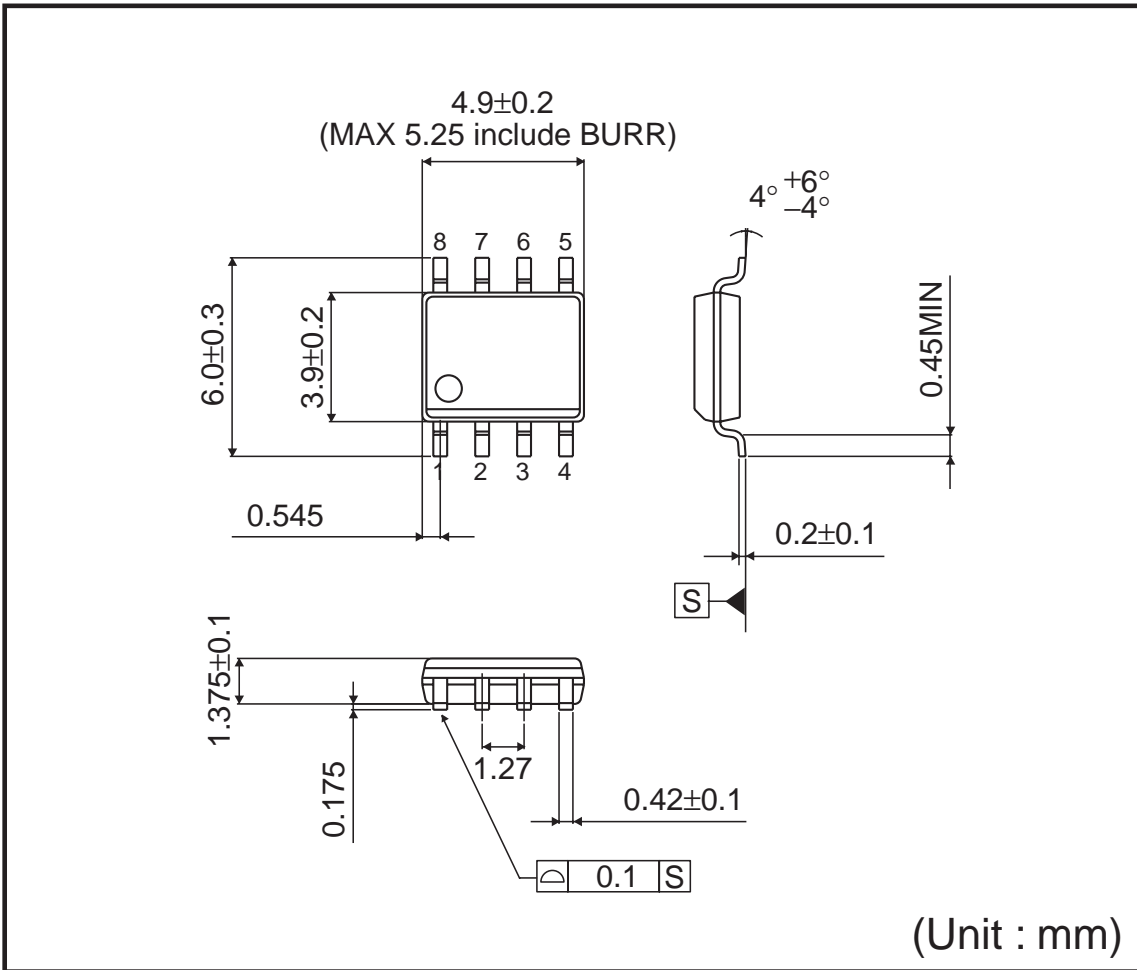

<Tape and Reel information>

Tape	Embossed carrier tape
Quantity	2500pcs
Direction of feed	E2 (The direction is the 1pin of product is at the upper left when you hold reel on the left hand and you pull out the tape on the right hand)

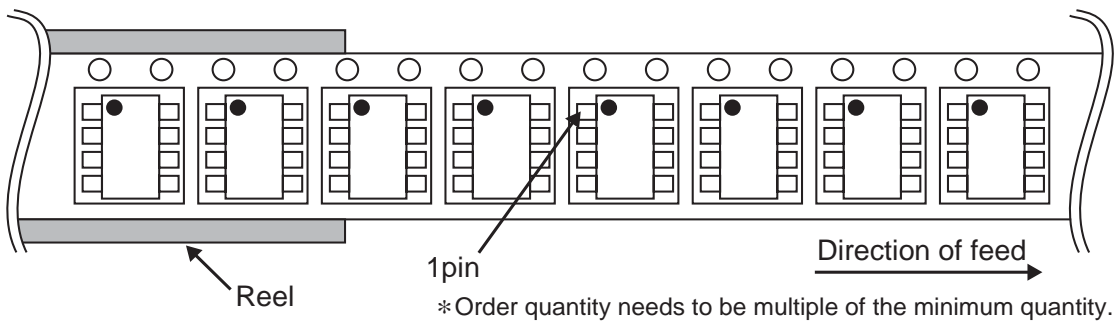

●Physical Dimension Tape and Reel Information – Continued

MSOP8

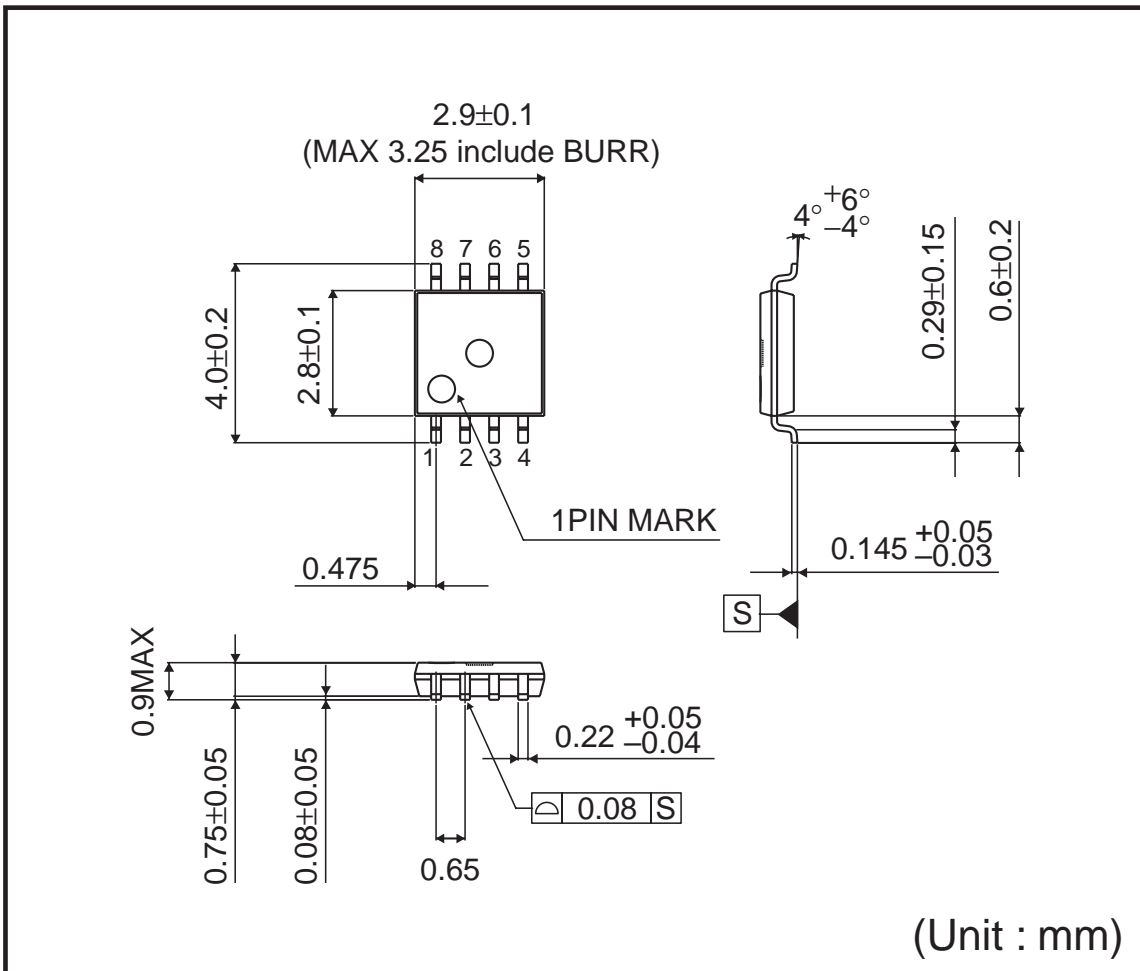

<Tape and Reel information>

Tape	Embossed carrier tape
Quantity	3000pcs
Direction of feed	TR (The direction is the 1pin of product is at the upper right when you hold reel on the left hand and you pull out the tape on the right hand)

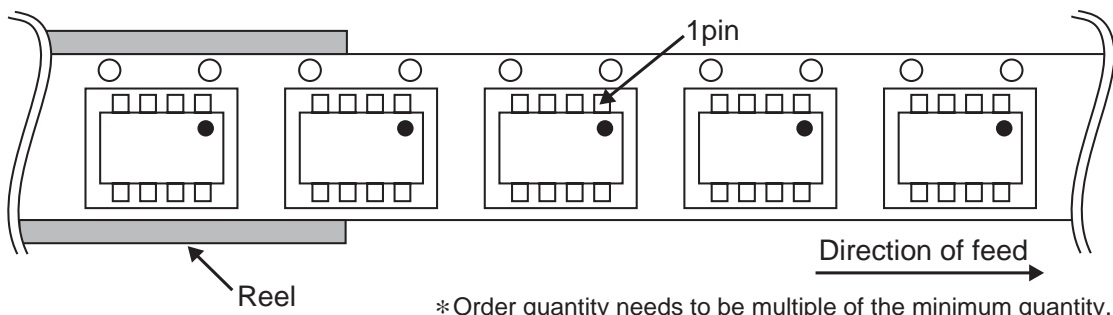

*Order quantity needs to be multiple of the minimum quantity.

● Marking Diagrams

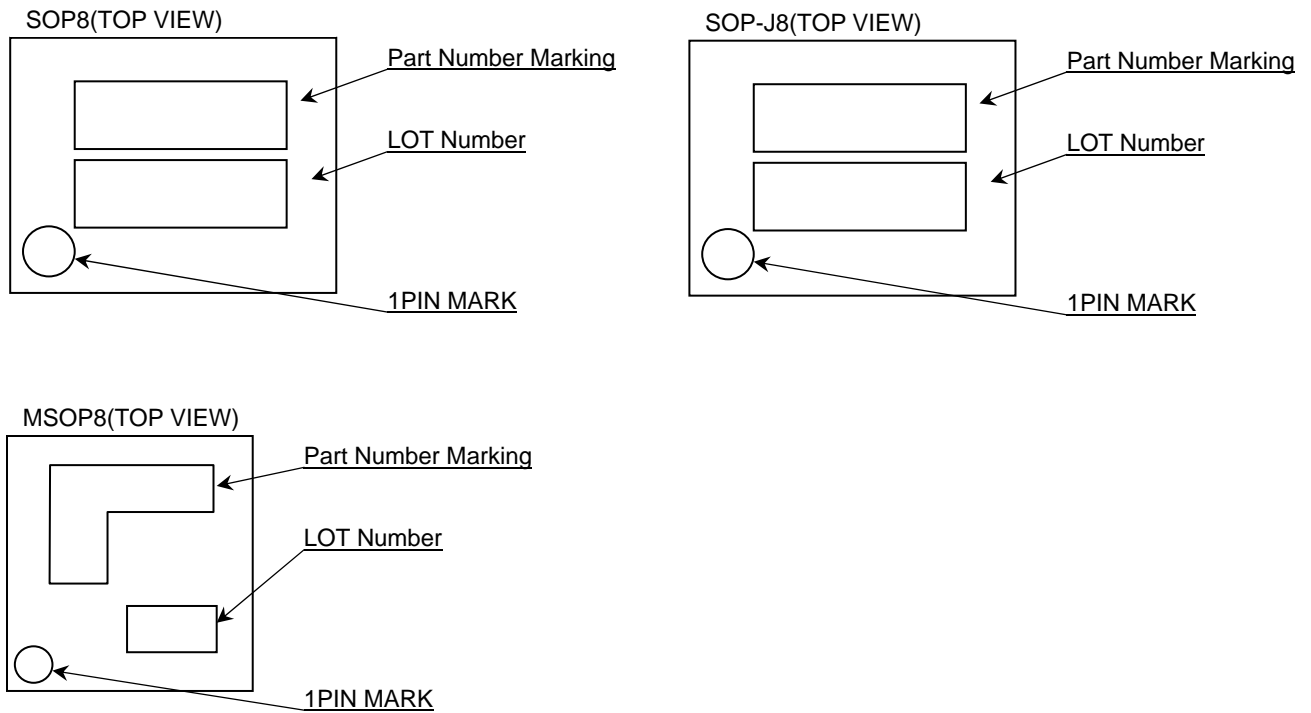

● Marking Information

Capacity	Product Name Marking	Package Type
2K	RH56	SOP8
	RH56	SOP-J8
4K	RH66	SOP8
	RH66	SOP-J8
	RH66	MSOP8
8K	RH76	SOP8
	RH76	SOP-J8
16K	RH86	SOP8
	RH86	SOP-J8

●Revision History

Date	Revision	Changes
31.Aug.2012	001	New Release
6.Nov.2013	002	P.1 Added AEC-Q100 Qualified P.2 Changed Unit of Rd P.22 Update Product Code Description.

Notice

Precaution on using ROHM Products

1. If you intend to use our Products in devices requiring extremely high reliability (such as medical equipment ^(Note 1), aircraft/spacecraft, nuclear power controllers, etc.) and whose malfunction or failure may cause loss of human life, bodily injury or serious damage to property ("Specific Applications"), please consult with the ROHM sales representative in advance. Unless otherwise agreed in writing by ROHM in advance, ROHM shall not be in any way responsible or liable for any damages, expenses or losses incurred by you or third parties arising from the use of any ROHM's Products for Specific Applications.

(Note1) Medical Equipment Classification of the Specific Applications

JAPAN	USA	EU	CHINA
CLASS III	CLASS III	CLASS II b	CLASS III
CLASS IV		CLASS III	

2. ROHM designs and manufactures its Products subject to strict quality control system. However, semiconductor products can fail or malfunction at a certain rate. Please be sure to implement, at your own responsibilities, adequate safety measures including but not limited to fail-safe design against the physical injury, damage to any property, which a failure or malfunction of our Products may cause. The following are examples of safety measures:
 - [a] Installation of protection circuits or other protective devices to improve system safety
 - [b] Installation of redundant circuits to reduce the impact of single or multiple circuit failure
3. Our Products are not designed under any special or extraordinary environments or conditions, as exemplified below. Accordingly, ROHM shall not be in any way responsible or liable for any damages, expenses or losses arising from the use of any ROHM's Products under any special or extraordinary environments or conditions. If you intend to use our Products under any special or extraordinary environments or conditions (as exemplified below), your independent verification and confirmation of product performance, reliability, etc, prior to use, must be necessary:
 - [a] Use of our Products in any types of liquid, including water, oils, chemicals, and organic solvents
 - [b] Use of our Products outdoors or in places where the Products are exposed to direct sunlight or dust
 - [c] Use of our Products in places where the Products are exposed to sea wind or corrosive gases, including Cl₂, H₂S, NH₃, SO₂, and NO₂
 - [d] Use of our Products in places where the Products are exposed to static electricity or electromagnetic waves
 - [e] Use of our Products in proximity to heat-producing components, plastic cords, or other flammable items
 - [f] Sealing or coating our Products with resin or other coating materials
 - [g] Use of our Products without cleaning residue of flux (even if you use no-clean type fluxes, cleaning residue of flux is recommended); or Washing our Products by using water or water-soluble cleaning agents for cleaning residue after soldering
 - [h] Use of the Products in places subject to dew condensation
4. The Products are not subject to radiation-proof design.
5. Please verify and confirm characteristics of the final or mounted products in using the Products.
6. In particular, if a transient load (a large amount of load applied in a short period of time, such as pulse. is applied, confirmation of performance characteristics after on-board mounting is strongly recommended. Avoid applying power exceeding normal rated power; exceeding the power rating under steady-state loading condition may negatively affect product performance and reliability.
7. De-rate Power Dissipation (Pd) depending on Ambient temperature (Ta). When used in sealed area, confirm the actual ambient temperature.
8. Confirm that operation temperature is within the specified range described in the product specification.
9. ROHM shall not be in any way responsible or liable for failure induced under deviant condition from what is defined in this document.

Precaution for Mounting / Circuit board design

1. When a highly active halogenous (chlorine, bromine, etc.) flux is used, the residue of flux may negatively affect product performance and reliability.
2. In principle, the reflow soldering method must be used; if flow soldering method is preferred, please consult with the ROHM representative in advance.

For details, please refer to ROHM Mounting specification

Precautions Regarding Application Examples and External Circuits

1. If change is made to the constant of an external circuit, please allow a sufficient margin considering variations of the characteristics of the Products and external components, including transient characteristics, as well as static characteristics.
2. You agree that application notes, reference designs, and associated data and information contained in this document are presented only as guidance for Products use. Therefore, in case you use such information, you are solely responsible for it and you must exercise your own independent verification and judgment in the use of such information contained in this document. ROHM shall not be in any way responsible or liable for any damages, expenses or losses incurred by you or third parties arising from the use of such information.

Precaution for Electrostatic

This Product is electrostatic sensitive product, which may be damaged due to electrostatic discharge. Please take proper caution in your manufacturing process and storage so that voltage exceeding the Products maximum rating will not be applied to Products. Please take special care under dry condition (e.g. Grounding of human body / equipment / solder iron, isolation from charged objects, setting of Ionizer, friction prevention and temperature / humidity control).

Precaution for Storage / Transportation

1. Product performance and soldered connections may deteriorate if the Products are stored in the places where:
 - [a] the Products are exposed to sea winds or corrosive gases, including Cl₂, H₂S, NH₃, SO₂, and NO₂
 - [b] the temperature or humidity exceeds those recommended by ROHM
 - [c] the Products are exposed to direct sunshine or condensation
 - [d] the Products are exposed to high Electrostatic
2. Even under ROHM recommended storage condition, solderability of products out of recommended storage time period may be degraded. It is strongly recommended to confirm solderability before using Products of which storage time is exceeding the recommended storage time period.
3. Store / transport cartons in the correct direction, which is indicated on a carton with a symbol. Otherwise bent leads may occur due to excessive stress applied when dropping of a carton.
4. Use Products within the specified time after opening a humidity barrier bag. Baking is required before using Products of which storage time is exceeding the recommended storage time period.

Precaution for Product Label

QR code printed on ROHM Products label is for ROHM's internal use only.

Precaution for Disposition

When disposing Products please dispose them properly using an authorized industry waste company.

Precaution for Foreign Exchange and Foreign Trade act

Since our Products might fall under controlled goods prescribed by the applicable foreign exchange and foreign trade act, please consult with ROHM representative in case of export.

Precaution Regarding Intellectual Property Rights

1. All information and data including but not limited to application example contained in this document is for reference only. ROHM does not warrant that foregoing information or data will not infringe any intellectual property rights or any other rights of any third party regarding such information or data. ROHM shall not be in any way responsible or liable for infringement of any intellectual property rights or other damages arising from use of such information or data.:
2. No license, expressly or implied, is granted hereby under any intellectual property rights or other rights of ROHM or any third parties with respect to the information contained in this document.

Other Precaution

1. This document may not be reprinted or reproduced, in whole or in part, without prior written consent of ROHM.
2. The Products may not be disassembled, converted, modified, reproduced or otherwise changed without prior written consent of ROHM.
3. In no event shall you use in any way whatsoever the Products and the related technical information contained in the Products or this document for any military purposes, including but not limited to, the development of mass-destruction weapons.
4. The proper names of companies or products described in this document are trademarks or registered trademarks of ROHM, its affiliated companies or third parties.

General Precaution

1. Before you use our Products, you are requested to carefully read this document and fully understand its contents. ROHM shall not be in any way responsible or liable for failure, malfunction or accident arising from the use of any ROHM's Products against warning, caution or note contained in this document.
2. All information contained in this document is current as of the issuing date and subject to change without any prior notice. Before purchasing or using ROHM's Products, please confirm the latest information with a ROHM sales representative.
3. The information contained in this document is provided on an "as is" basis and ROHM does not warrant that all information contained in this document is accurate and/or error-free. ROHM shall not be in any way responsible or liable for any damages, expenses or losses incurred by you or third parties resulting from inaccuracy or errors of or concerning such information.

Mouser Electronics

Authorized Distributor

Click to View Pricing, Inventory, Delivery & Lifecycle Information:

ROHM Semiconductor:

[BR93H56RFJ-WCE2](#) [BR93H56RF-WCE2](#) [BR93H66RFVM-WCTR](#) [BR93H66RF-WCE2](#) [BR93H66RFJ-WCE2](#)
[BR93H76RF-WCE2](#) [BR93H86RFJ-WCE2](#) [BR93H86RF-WCE2](#)