

CM1224

2 and 4-Channel Low Capacitance ESD Protection Arrays

Product Description

The CM1224 family of diode arrays has been designed to provide ESD protection for electronic components or subsystems requiring minimal capacitive loading. These devices are ideal for protecting systems with high data and clock rates or for circuits requiring low capacitive loading. Each ESD channel consists of a pair of diodes in series which steer the positive or negative ESD current pulse to either the positive (V_P) or negative (V_N) supply rail. A Zener diode is embedded between V_P and V_N , offering two advantages. First, it protects the V_{CC} rail against ESD strikes, and second, it eliminates the need for a bypass capacitor that would otherwise be needed for absorbing positive ESD strikes to ground. The CM1224 will protect against ESD pulses up to ± 8 kV per the IEC 61000-4-2 standard.

These devices are particularly well-suited for protecting systems using high-speed ports such as USB 2.0, IEEE1394 (Firewire[®], iLink[™]), Serial ATA, DVI, HDMI and corresponding ports in removable storage, digital camcorders, DVD-RW drives and other applications where extremely low loading capacitance with ESD protection are required.

The CM1224 family of devices has lead-free finishing in a small package footprint.

Features

- Two or Four Channels of ESD Protection
- Provides ESD Protection to IEC61000-4-2 Level 4 ± 8 kV Contact Discharge
- Low Channel Input Capacitance of 0.7 pF Typical
- Minimal Capacitance Change with Temperature and Voltage
- Channel Input Capacitance Matching of 0.02 pF Typical is Ideal for Differential Signals
- Zener Diode Protects Supply Rail and Eliminates the Need for External By-pass Capacitors
- Low Clamping Voltage (V_{CLAMP}) at 10 V
- Low Dynamic Resistance (R_{DYN}) at 1.08 Ω
- Each I/O Pin Can Withstand Over 1000 ESD Strikes
- Available in SOT and MSOP Lead-free Packages
- These Devices are Pb-Free and are RoHS Compliant

Applications

- USB2.0 Ports at 480 Mbps in desktop PCs, Notebooks and Peripherals
- IEEE1394 Firewire[®] Ports at 400 Mbps / 800 Mbps
- DVI Ports, HDMI Ports in Notebooks, Set Top Boxes, Digital TVs, LCD Displays
- Serial ATA Ports in Desktop PCs and Hard Disk Drives
- PCI Express Ports

- General Purpose High-speed Data Line ESD Protection



ON Semiconductor[®]

<http://onsemi.com>

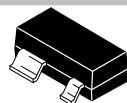

SOT-143
SR SUFFIX
CASE 318A



SOT23-6
SO SUFFIX
CASE 527AJ

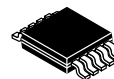

MSOP 10
MR SUFFIX
CASE 846AE

BLOCK DIAGRAM

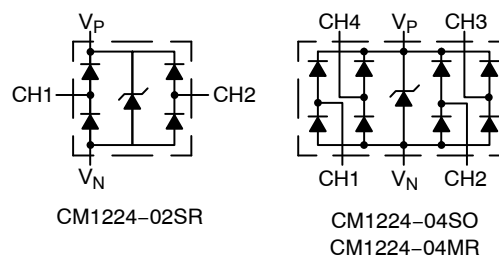

MARKING DIAGRAM

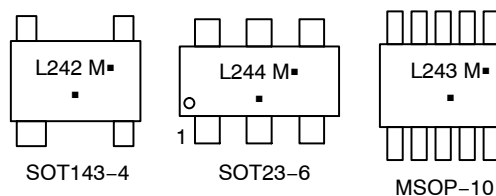

L24x = Specific Device Code
M = Date Code
▪ = Pb-Free Package
(Note: Microdot may be in either location)

ORDERING INFORMATION

Device	Package	Shipping
CM1224-02SR	SOT143-4 (Pb-Free)	3000/Tape & Reel
CM1224-04SO	SOT23-6 (Pb-Free)	3000/Tape & Reel
CM1224-04MR	MSOP-10 (Pb-Free)	4000/Tape & Reel

†For information on tape and reel specifications, including part orientation and tape sizes, please refer to our Tape and Reel Packaging Specification Brochure, BRD8011/D.

Table 1. PIN DESCRIPTIONS

2-Channel, 4-Lead SOT143-4 Package			
Pin	Name	Type	Description
1	V _N	GND	Negative voltage supply rail
2	CH1	I/O	ESD Channel
3	CH2	I/O	ESD Channel
4	V _P	PWR	Positive voltage supply rail

4-Channel, 6-Lead SOT23-6 Packages			
Pin	Name	Type	Description
1	CH1	I/O	ESD Channel
2	V _N	GND	Negative voltage supply rail
3	CH2	I/O	ESD Channel
4	CH3	I/O	ESD Channel
5	V _P	PWR	Positive voltage supply rail
6	CH4	I/O	ESD Channel

4-Channel, 10-Lead MSOP-10 Packages			
Pin	Name	Type	Description
1	CH1	I/O	ESD Channel
2	NC		No Connect
3	V _P	PWR	Positive voltage supply rail
4	CH2	I/O	ESD Channel
5	NC		No Connect
6	CH3	I/O	ESD Channel
7	NC		No Connect
8	V _N	GND	Negative voltage supply rail
9	CH4	I/O	ESD Channel
10	NC		No Connect

PACKAGE / PINOUT DIAGRAMS

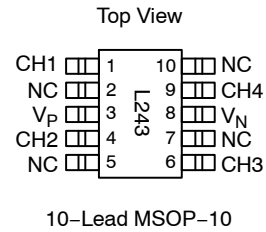
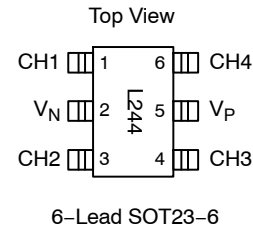
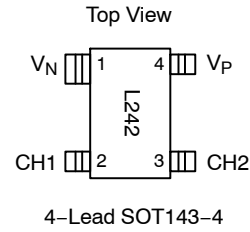

SPECIFICATIONS

Table 2. ABSOLUTE MAXIMUM RATINGS

Parameter	Rating	Units
Operating Supply Voltage (V _P - V _N)	6.0	V
Operating Temperature Range	-40 to +85	°C
Storage Temperature Range	-65 to +150	°C
DC Voltage at any Channel Input	(V _N - 0.5) to (V _P + 0.5)	V

Stresses exceeding Maximum Ratings may damage the device. Maximum Ratings are stress ratings only. Functional operation above the Recommended Operating Conditions is not implied. Extended exposure to stresses above the Recommended Operating Conditions may affect device reliability.

CM1224

Table 3. STANDARD OPERATING CONDITIONS

Parameter	Rating	Units
Operating Temperature Range	-40 to +85	°C
Package Power Rating SOT23-3, SOT143-4, SOT23-5 and SOT23-6 Packages MSOP-10 Package	225 400	mW

Table 4. ELECTRICAL OPERATING CHARACTERISTICS (Note1)

Symbol	Parameter	Conditions	Min	Typ	Max	Units
V _P	Operating Supply Voltage (V _P -V _N)			3.3	5.5	V
I _P	Operating Supply Current	(V _P -V _N) = 3.3 V			8.0	μA
V _F	Diode Forward Voltage Top Diode Bottom Diode	I _F = 8 mA; T _A = 25°C	0.6 0.6	0.8 0.8	0.95 0.95	V
I _{LEAK}	Channel Leakage Current	T _A = 25°C; V _P = 5 V, V _N = 0 V		±0.1	±1.0	μA
C _{IN}	Channel Input Capacitance	At 1 MHz, V _P = 3.3 V, V _N = 0 V, V _{IN} = 1.65 V	0.6	0.7	0.8	pF
ΔC _{IN}	Channel Input Capacitance Matching	At 1 MHz, V _P = 3.3 V, V _N = 0 V, V _{IN} = 1.65 V		0.02		pF
V _{ESD}	ESD Protection - Peak Discharge Voltage at any channel input, in system Contact discharge per IEC 61000-4-2 standard	T _A = 25°C (Notes 2 and 3)	±8			kV
V _{CL}	Channel Clamp Voltage Positive Transients Negative Transients	T _A = 25°C, I _{PP} = 1A, t _p = 8/20 μS; (Note 3)		+10 -1.8		V
R _{DYN}	Dynamic Resistance Positive Transients Negative Transients	I _{PP} = 1A, t _p = 8/20 μS Any I/O pin to Ground; (Note 3)		1.08 0.66		Ω

1. All parameters specified at T_A = -40°C to +85°C unless otherwise noted.
2. Standard IEC 61000-4-2 with C_{Discharge} = 150 pF, R_{Discharge} = 330 Ω, V_P = 3.3 V, V_N grounded.
3. These measurements performed with no external capacitor on V_P (V_P floating).

PERFORMANCE INFORMATION

Input Channel Capacitance Performance Curves

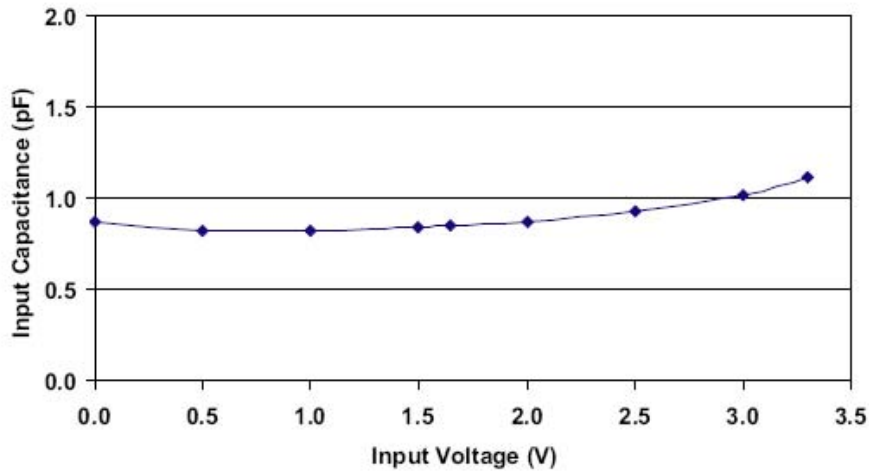

Typical Variation of C_{IN} vs. V_{IN}

($f=1\text{MHz}$, $V_P = 3.3\text{V}$, $V_N = 0\text{V}$, $0.1 \mu\text{F}$ chip capacitor between V_P and V_N , 25°C)

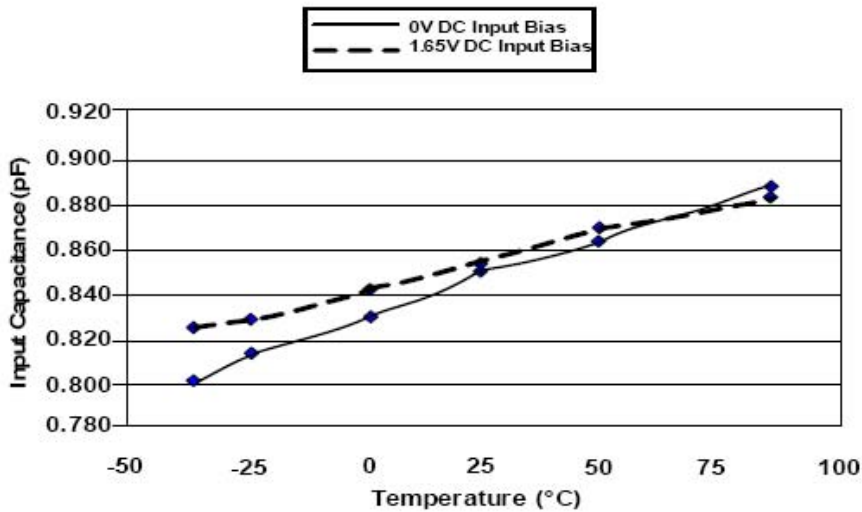

Typical Variation of C_{IN} vs. Temp

($f=1\text{MHz}$, $V_{IN}=30\text{mV}$, $V_P = 3.3\text{V}$, $V_N = 0\text{V}$, $0.1 \mu\text{F}$ chip capacitor between V_P and V_N)

CM1224

PERFORMANCE INFORMATION (Cont'd)

Typical Filter Performance (nominal conditions unless specified otherwise, 50 Ohm Environment)

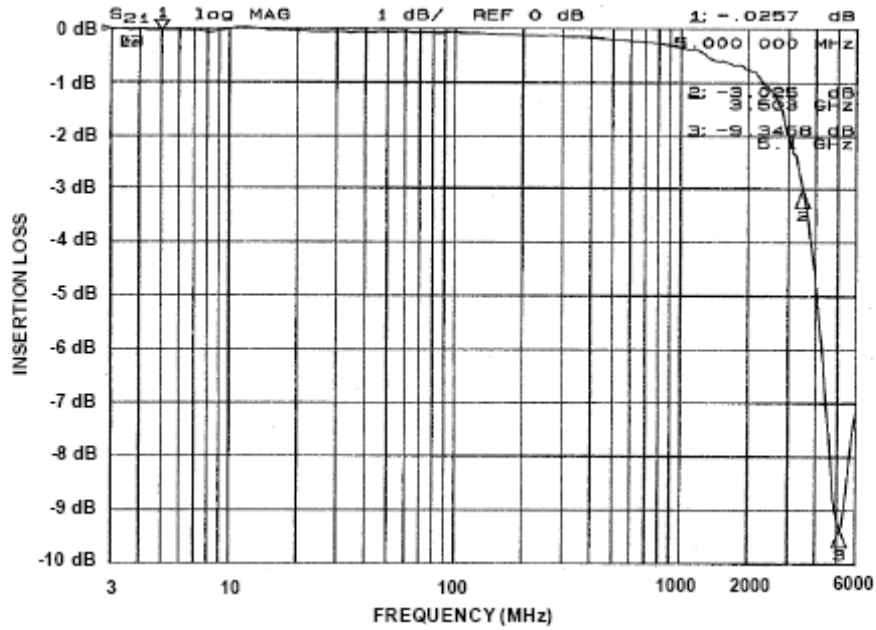

Figure 1. Insertion Loss (S21) vs. Frequency (0 V DC Bias, $V_p = 3.3$ V)

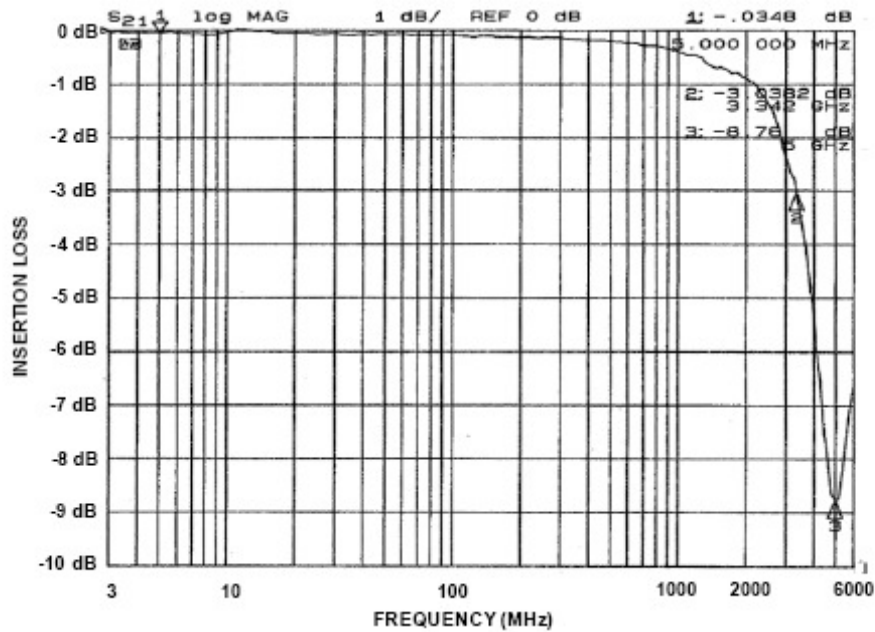

Figure 2. Insertion Loss (S21) vs. Frequency (2.5 V DC Bias, $V_p = 3.3$ V)

APPLICATION INFORMATION

Design Considerations

To realize the maximum protection against ESD pulses, care must be taken in the PCB layout to minimize parasitic series inductances on the Supply/ Ground rails as well as the signal trace segment between the signal input (typically a connector) and the ESD protection device. Figure 3 illustrates an example of a positive ESD pulse striking an input channel. The parasitic series inductance back to the power supply is represented by L_1 and L_2 . The voltage V_{CL} on the line being protected is:

$$V_{CL} = \text{Fwd voltage drop of } D_1 + V_{SUPPLY} + L_1 \times d(I_{ESD}) / dt + L_2 \times d(I_{ESD}) / dt$$

where I_{ESD} is the ESD current pulse, and V_{SUPPLY} is the positive supply voltage.

An ESD current pulse can rise from zero to its peak value in a very short time. As an example, a level 4 contact discharge per the IEC61000-4-2 standard results in a current pulse that rises from 0 to 30 Amps in 1ns. Here $d(I_{ESD})/dt$ can be approximated by $\Delta I_{ESD}/\Delta t$, or $30/(1 \times 10^{-9})$. So just 10 nH of series inductance (L_1 and L_2 combined) will lead to a 300 V increment in V_{CL} !

Similarly for negative ESD pulses, parasitic series inductance from the V_N pin to the ground rail will lead to drastically increased negative voltage on the line being protected.

The CM1224 has an integrated Zener diode between V_P and V_N . This greatly reduces the effect of supply rail inductance L_2 on V_{CL} by clamping V_P at the breakdown voltage of the Zener diode. However, for the lowest possible V_{CL} , especially when V_P is biased at a voltage significantly below the Zener breakdown voltage, it is recommended that a 0.22 μF ceramic chip capacitor be connected between V_P and the ground plane.

As a general rule, the ESD Protection Array should be located as close as possible to the point of entry of expected electrostatic discharges. The power supply bypass capacitor mentioned earlier should be as close to the V_P pin of the Protection Array as possible, with minimum PCB trace lengths to the power supply, ground planes and between the signal input and the ESD device to minimize stray series inductance.

Additional Information

See also ON Semiconductor Application Note “Design Considerations for ESD Protection”.

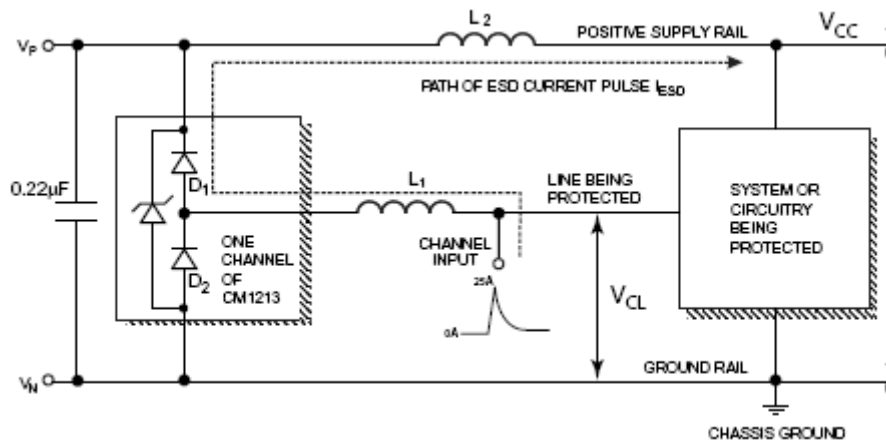

Figure 3. Application of Positive ESD Pulse between Input Channel and Ground

CM1224

MECHANICAL DETAILS

The CM1224 is available in SOT143-4, SOT23-6 and MSOP-10 packages with lead-free finishing. The various package drawings are presented below.

SOT143-4, SOT23-6 and MSOP-10 Mechanical Specifications

The CM1224-02SR devices are supplied in 4-pin SOT143 packages, the CM1224-04SO devices are packaged in 6-pin SOT23 and the CM1224-04MR in 10-lead MSOP packages. Dimensions are presented below.

Table 5. TAPE AND REEL SPECIFICATIONS

Part Number	Chip Size (mm)	Pocket Size (mm) $B_0 \times A_0 \times K_0$	Tape Width W	Reel Diameter	Qty per Reel	P_0	P_1
CM1224-02SR	2.92 X 2.37 X 1.01	2.60 X 3.15 X 1.20	8 mm	178 mm (7")	3000	4 mm	4 mm
CM1224-04SO	2.90 X 2.80 X 1.45	3.20 X 3.20 X 1.40	8 mm	178 mm (7")	3000	4 mm	4 mm
CM1224-04MR	3.00 X 3.00 X 0.85	3.30 X 5.30 X 1.30	12 mm	330 mm (13")	4000	4 mm	8 mm

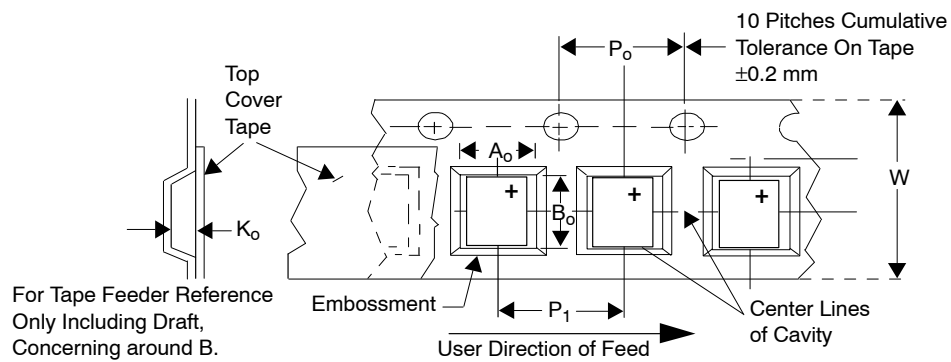

MECHANICAL CASE OUTLINE PACKAGE DIMENSIONS

ON Semiconductor®

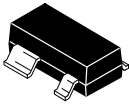

SCALE 4:1

SOT-143 CASE 318A-06 ISSUE U

DATE 07 SEP 2011

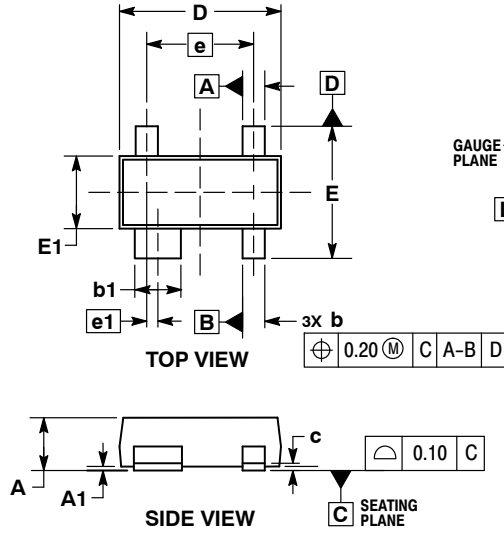

NOTES:

1. DIMENSIONING AND TOLERANCING PER ASME Y14.5M, 1994.
2. CONTROLLING DIMENSION: MILLIMETERS.
3. MAXIMUM LEAD THICKNESS INCLUDES LEAD FINISH. MINIMUM LEAD THICKNESS IS THE MINIMUM THICKNESS OF BASE MATERIAL.
4. DIMENSIONS D AND E DO NOT INCLUDE MOLD FLASH, PROTRUSIONS, OR GATE BURRS. MOLD FLASH, PROTRUSIONS, AND GATE BURRS SHALL NOT EXCEED 0.25 PER SIDE. DIMENSION E1 DOES NOT INCLUDE INTERLEAD FLASH OR PROTRUSION. INTERLEAD FLASH AND PROTRUSION SHALL NOT EXCEED 0.25 PER SIDE.
5. DIMENSIONS D AND E1 ARE DETERMINED AT DATUM H.
6. DATUMS A AND B ARE DETERMINED AT DATUM H.

DIM	MILLIMETERS	
	MIN	MAX
A	0.80	1.12
A1	0.01	0.15
b	0.30	0.51
b1	0.76	0.94
c	0.08	0.20
D	2.80	3.05
E	2.10	2.64
E1	1.20	1.40
e	1.92 BSC	
e1	0.20 BSC	
L	0.35	0.70
L2	0.25 BSC	

RECOMMENDED SOLDERING FOOTPRINT

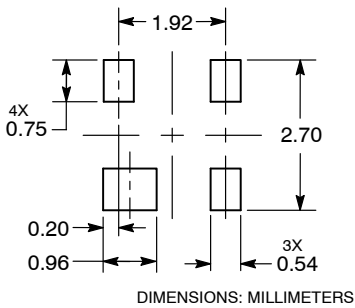

GENERIC MARKING DIAGRAM*

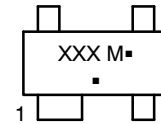

XXX = Specific Device Code
M = Date Code
▪ = Pb-Free Package

(Note: Microdot may be in either location)

*This information is generic. Please refer to device data sheet for actual part marking. Pb-Free indicator, "G" or microdot "▪", may or may not be present.

- | | | | | | |
|---|---|---|---|--|--|
| <p>STYLE 1:
PIN 1. COLLECTOR
2. EMITTER
3. EMITTER
4. BASE</p> | <p>STYLE 2:
PIN 1. SOURCE
2. DRAIN
3. GATE 1
4. GATE 2</p> | <p>STYLE 3:
PIN 1. GROUND
2. SOURCE
3. INPUT
4. OUTPUT</p> | <p>STYLE 4:
PIN 1. OUTPUT
2. GROUND
3. GROUND
4. INPUT</p> | <p>STYLE 5:
PIN 1. SOURCE
2. DRAIN
3. GATE 1
4. SOURCE</p> | <p>STYLE 6:
PIN 1. GND
2. RF IN
3. VREG
4. RF OUT</p> |
| <p>STYLE 7:
PIN 1. SOURCE
2. GATE
3. DRAIN
4. SOURCE</p> | <p>STYLE 8:
PIN 1. SOURCE
2. GATE
3. DRAIN
4. N/C</p> | <p>STYLE 9:
PIN 1. GND
2. IOUT
3. VCC
4. VREF</p> | <p>STYLE 10:
PIN 1. DRAIN
2. N/C
3. SOURCE
4. GATE</p> | <p>STYLE 11:
PIN 1. SOURCE
2. GATE 1
3. GATE 2
4. DRAIN</p> | |

DOCUMENT NUMBER:	98ASB42227B	Electronic versions are uncontrolled except when accessed directly from the Document Repository. Printed versions are uncontrolled except when stamped "CONTROLLED COPY" in red.
DESCRIPTION:	SOT-143	PAGE 1 OF 1

ON Semiconductor and ON are trademarks of Semiconductor Components Industries, LLC dba ON Semiconductor or its subsidiaries in the United States and/or other countries. ON Semiconductor reserves the right to make changes without further notice to any products herein. ON Semiconductor makes no warranty, representation or guarantee regarding the suitability of its products for any particular purpose, nor does ON Semiconductor assume any liability arising out of the application or use of any product or circuit, and specifically disclaims any and all liability, including without limitation special, consequential or incidental damages. ON Semiconductor does not convey any license under its patent rights nor the rights of others.

MECHANICAL CASE OUTLINE

PACKAGE DIMENSIONS

ON Semiconductor®



SOT-23, 6 Lead
CASE 527AJ
ISSUE B



SCALE 2:1

DATE 29 FEB 2012

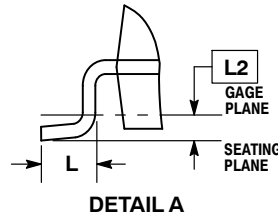
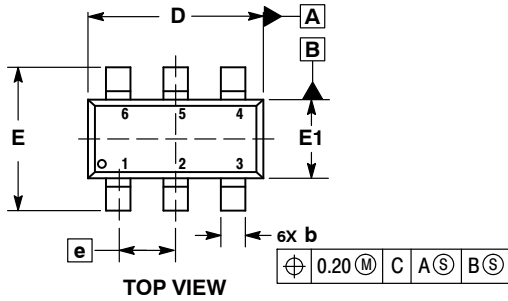

- NOTES:
1. DIMENSIONING AND TOLERANCING PER ASME Y14.5M, 1994.
 2. CONTROLLING DIMENSION: MILLIMETERS.
 3. DATUM C IS THE SEATING PLANE.

MILLIMETERS		
DIM	MIN	MAX
A	---	1.45
A1	0.00	0.15
A2	0.90	1.30
b	0.20	0.50
c	0.08	0.26
D	2.70	3.00
E	2.50	3.10
E1	1.30	1.80
e	0.95 BSC	
L	0.20	0.60
L2	0.25 BSC	

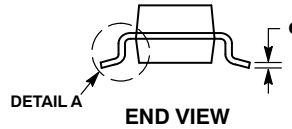
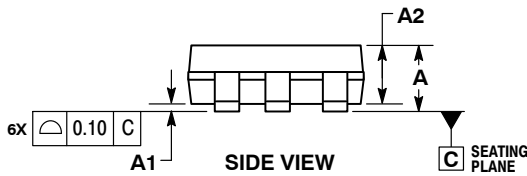

GENERIC MARKING DIAGRAM*

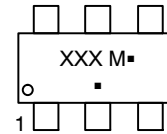

- XXX = Specific Device Code
- M = Date Code
- = Pb-Free Package

(Note: Microdot may be in either location)

*This information is generic. Please refer to device data sheet for actual part marking. Pb-Free indicator, "G" or microdot "▪", may or may not be present.

RECOMMENDED SOLDERING FOOTPRINT*

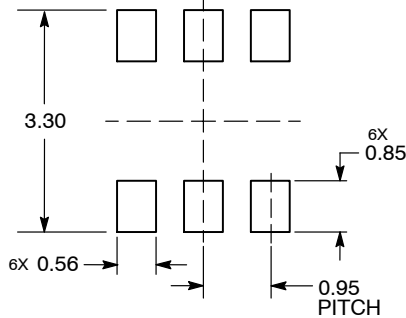

DIMENSIONS: MILLIMETERS

*For additional information on our Pb-Free strategy and soldering details, please download the ON Semiconductor Soldering and Mounting Techniques Reference Manual, SOLDERRM/D.

DOCUMENT NUMBER:	98AON34321E	Electronic versions are uncontrolled except when accessed directly from the Document Repository. Printed versions are uncontrolled except when stamped "CONTROLLED COPY" in red.
DESCRIPTION:	SOT-23, 6 LEAD	PAGE 1 OF 1

ON Semiconductor and are trademarks of Semiconductor Components Industries, LLC dba ON Semiconductor or its subsidiaries in the United States and/or other countries. ON Semiconductor reserves the right to make changes without further notice to any products herein. ON Semiconductor makes no warranty, representation or guarantee regarding the suitability of its products for any particular purpose, nor does ON Semiconductor assume any liability arising out of the application or use of any product or circuit, and specifically disclaims any and all liability, including without limitation special, consequential or incidental damages. ON Semiconductor does not convey any license under its patent rights nor the rights of others.

MECHANICAL CASE OUTLINE

PACKAGE DIMENSIONS

ON Semiconductor®



SCALE 1:1

MSOP10, 3x3
CASE 846AE
ISSUE A

DATE 20 JUN 2017

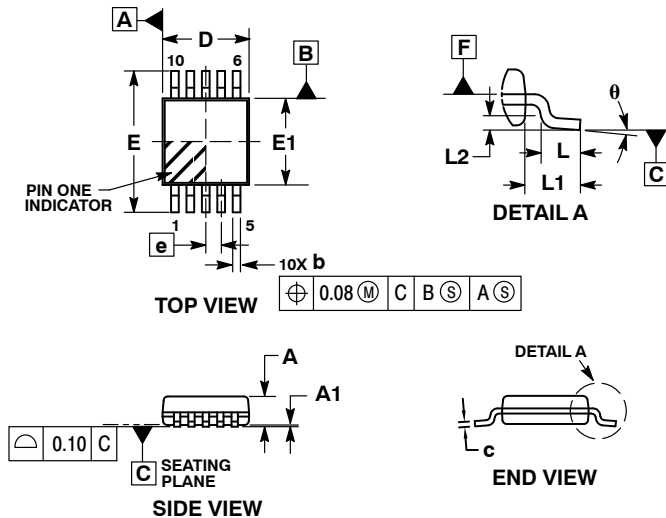

NOTES:

1. DIMENSIONS AND TOLERANCING PER ASME Y14.5M, 1994.
2. CONTROLLING DIMENSIONS: MILLIMETERS.
3. DIMENSION b DOES NOT INCLUDE DAMBAR PROTRUSION. ALLOWABLE DAMBAR PROTRUSION SHALL BE 0.10 MM IN EXCESS OF MAXIMUM MATERIAL CONDITION.
4. DIMENSION D DOES NOT INCLUDE MOLD FLASH, PROTRUSIONS, OR GATE BURRS. MOLD FLASH, PROTRUSIONS, OR GATE BURRS SHALL NOT EXCEED 0.15 MM PER SIDE. DIMENSION E DOES NOT INCLUDE INTERLEAD FLASH OR PROTRUSION. INTERLEAD FLASH OR PROTRUSION SHALL NOT EXCEED 0.25 MM PER SIDE. DIMENSIONS D AND E ARE DETERMINED AT DATUM F.
5. DATUMS A AND B TO BE DETERMINED AT DATUM F.
6. A1 IS DEFINED AS THE VERTICAL DISTANCE FROM THE SEATING PLANE TO THE LOWEST POINT ON THE PACKAGE BODY.

DIM	MILLIMETERS		
	MIN	NOM	MAX
A	---	---	1.10
A1	0.00	0.05	0.15
A2	0.75	0.85	0.95
b	0.17	---	0.27
c	0.13	---	0.23
D	2.90	3.00	3.10
E	4.75	4.90	5.05
E1	2.90	3.00	3.10
e	0.50 BSC		
L	0.40	0.70	0.80
L1	0.95 REF		
L2	0.25 BSC		
θ	0°	---	8°

GENERIC MARKING DIAGRAM*

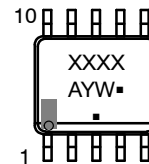

- XXXX = Specific Device Code
- A = Assembly Location
- Y = Year
- W = Work Week
- = Pb-Free Package

(Note: Microdot may be in either location)

*This information is generic. Please refer to device data sheet for actual part marking. Pb-Free indicator, "G" or microdot "▪", may or may not be present and may be in either location. Some products may not follow the Generic Marking.

RECOMMENDED SOLDERING FOOTPRINT*

*For additional information on our Pb-Free strategy and soldering details, please download the ON Semiconductor Soldering and Mounting Techniques Reference Manual, SOLDERM/D.

DOCUMENT NUMBER:	98AON34098E	Electronic versions are uncontrolled except when accessed directly from the Document Repository. Printed versions are uncontrolled except when stamped "CONTROLLED COPY" in red.
DESCRIPTION:	MSOP10, 3X3	PAGE 1 OF 1

ON Semiconductor and ON are trademarks of Semiconductor Components Industries, LLC dba ON Semiconductor or its subsidiaries in the United States and/or other countries. ON Semiconductor reserves the right to make changes without further notice to any products herein. ON Semiconductor makes no warranty, representation or guarantee regarding the suitability of its products for any particular purpose, nor does ON Semiconductor assume any liability arising out of the application or use of any product or circuit, and specifically disclaims any and all liability, including without limitation special, consequential or incidental damages. ON Semiconductor does not convey any license under its patent rights nor the rights of others.

onsemi, **Onsemi**, and other names, marks, and brands are registered and/or common law trademarks of Semiconductor Components Industries, LLC dba "**onsemi**" or its affiliates and/or subsidiaries in the United States and/or other countries. **onsemi** owns the rights to a number of patents, trademarks, copyrights, trade secrets, and other intellectual property. A listing of **onsemi**'s product/patent coverage may be accessed at www.onsemi.com/site/pdf/Patent-Marking.pdf. **onsemi** reserves the right to make changes at any time to any products or information herein, without notice. The information herein is provided "as-is" and **onsemi** makes no warranty, representation or guarantee regarding the accuracy of the information, product features, availability, functionality, or suitability of its products for any particular purpose, nor does **onsemi** assume any liability arising out of the application or use of any product or circuit, and specifically disclaims any and all liability, including without limitation special, consequential or incidental damages. Buyer is responsible for its products and applications using **onsemi** products, including compliance with all laws, regulations and safety requirements or standards, regardless of any support or applications information provided by **onsemi**. "Typical" parameters which may be provided in **onsemi** data sheets and/or specifications can and do vary in different applications and actual performance may vary over time. All operating parameters, including "Typicals" must be validated for each customer application by customer's technical experts. **onsemi** does not convey any license under any of its intellectual property rights nor the rights of others. **onsemi** products are not designed, intended, or authorized for use as a critical component in life support systems or any FDA Class 3 medical devices or medical devices with a same or similar classification in a foreign jurisdiction or any devices intended for implantation in the human body. Should Buyer purchase or use **onsemi** products for any such unintended or unauthorized application, Buyer shall indemnify and hold **onsemi** and its officers, employees, subsidiaries, affiliates, and distributors harmless against all claims, costs, damages, and expenses, and reasonable attorney fees arising out of, directly or indirectly, any claim of personal injury or death associated with such unintended or unauthorized use, even if such claim alleges that **onsemi** was negligent regarding the design or manufacture of the part. **onsemi** is an Equal Opportunity/Affirmative Action Employer. This literature is subject to all applicable copyright laws and is not for resale in any manner.

PUBLICATION ORDERING INFORMATION

LITERATURE FULFILLMENT:

Email Requests to: orderlit@onsemi.com

onsemi Website: www.onsemi.com

TECHNICAL SUPPORT

North American Technical Support:

Voice Mail: 1 800-282-9855 Toll Free USA/Canada

Phone: 011 421 33 790 2910

Europe, Middle East and Africa Technical Support:

Phone: 00421 33 790 2910

For additional information, please contact your local Sales Representative

Mouser Electronics

Authorized Distributor

Click to View Pricing, Inventory, Delivery & Lifecycle Information:

[onsemi:](#)

[CM1224-04SO](#) [CM1224-02SR](#) [CM1224-04MR](#)