

## ACNT-H313

### 2.5A Output Current IGBT Gate Drive Optocoupler in 15-mm Stretched SO8 Package

#### Description

The Broadcom<sup>®</sup> ACNT-H313 contains an LED, which is optically coupled to an integrated circuit with a power output stage. This optocoupler is ideally suited for driving power IGBTs and MOSFETs used in motor control inverter applications. The high operating voltage range of the output stage provides the drive voltages required by gate-controlled devices. The voltage and high peak output current supplied by this optocoupler can be used to IGBT directly. For IGBTs with higher ratings, this optocoupler can be used to drive a discrete power stage, which drives the IGBT gate. The ACNT-H313 has the highest insulation voltage of  $V_{IORM} = 2262 V_{PEAK}$  in the IEC/EN/DIN EN 60747-5-5.

#### Features

- 2.5A maximum peak output current
- 2.0A minimum peak output current
- 500-ns maximum propagation delay
- 350-ns maximum propagation delay difference
- 40-kV/ $\mu$ s minimum Common Mode Rejection (CMR) at  $V_{CM} = 2000V$
- $I_{CC} = 5.0$ -mA maximum supply current
- Under Voltage Lock-Out protection (UVLO) with hysteresis
- Wide operating  $V_{CC}$  range: 15V to 30V
- Industrial temperature range:  $-40^{\circ}C$  to  $105^{\circ}C$
- Safety approvals
  - UL Recognized 7500  $V_{RMS}$  for 1 min
  - CSA
  - IEC/EN/DIN EN 60747-5-5  $V_{IORM} = 2262 V_{PEAK}$

#### Applications

- High power system – 690  $V_{AC}$  drives
- IGBT/MOSFET gate drive
- AC and brushless DC motor drives
- Renewable energy inverters
- Industrial inverters
- Switching power supplies

**CAUTION!** Take normal static precautions in handling and assembly of this component to prevent damage and/or degradation that may be induced by ESD. The components featured in this data sheet are not to be used in military or aerospace applications or environments. The component is also not AEC-Q100 qualified and not recommended for automotive applications.

## Functional Diagram

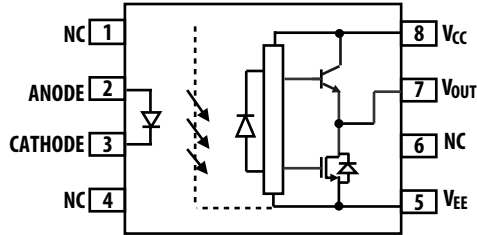

**NOTE:** NC denotes Not Connected, and a 0.1- $\mu$ F bypass capacity must be connected between pins  $V_{CC}$  and  $V_{EE}$ .

## Truth Table

LED	$V_{CC} - V_{EE}$ "POSITIVE GOING" (i.e., TURN-ON)	$V_{CC} - V_{EE}$ "NEGATIVE GOING" (i.e., TURN-OFF)	$V_O$
OFF	0V to 30V	0V to 30V	LOW
ON	0V to 11V	0V to 9.5V	LOW
ON	11V to 13.5V	9.5V to 12V	TRANSITION
ON	13.5V to 30V	12V to 30V	HIGH

## Ordering Information

ACNT-H313 is UL Recognized with 7500  $V_{RMS}$  for 1 minute per UL1577.

Part Number	Option	Package	Surface Mount	Tape and Reel	IEC/EN/DIN EN 60747-5-5 $V_{IORM} = 2262$ $V_{PEAK}$	Quantity
	RoHS Compliant					
ACNT-H313	-000E	15 mm Stretched SO-8	X		X	80 per tube
	-500E		X	X	X	1000 per reel

To order, choose a part number from the part number column and combine with the desired option from the option column to form an order entry.

Example 1:

ACNT-H313-500E to order a product in Surface Mount package in Tape and Reel packaging with IEC/EN/DIN EN 60747-5-5 Safety Approval and RoHS compliant.

Option data sheets are available. Contact your Broadcom sales representative or authorized distributor for information.

# Package Outline Drawings

## ACNT-H313 Outline Drawing

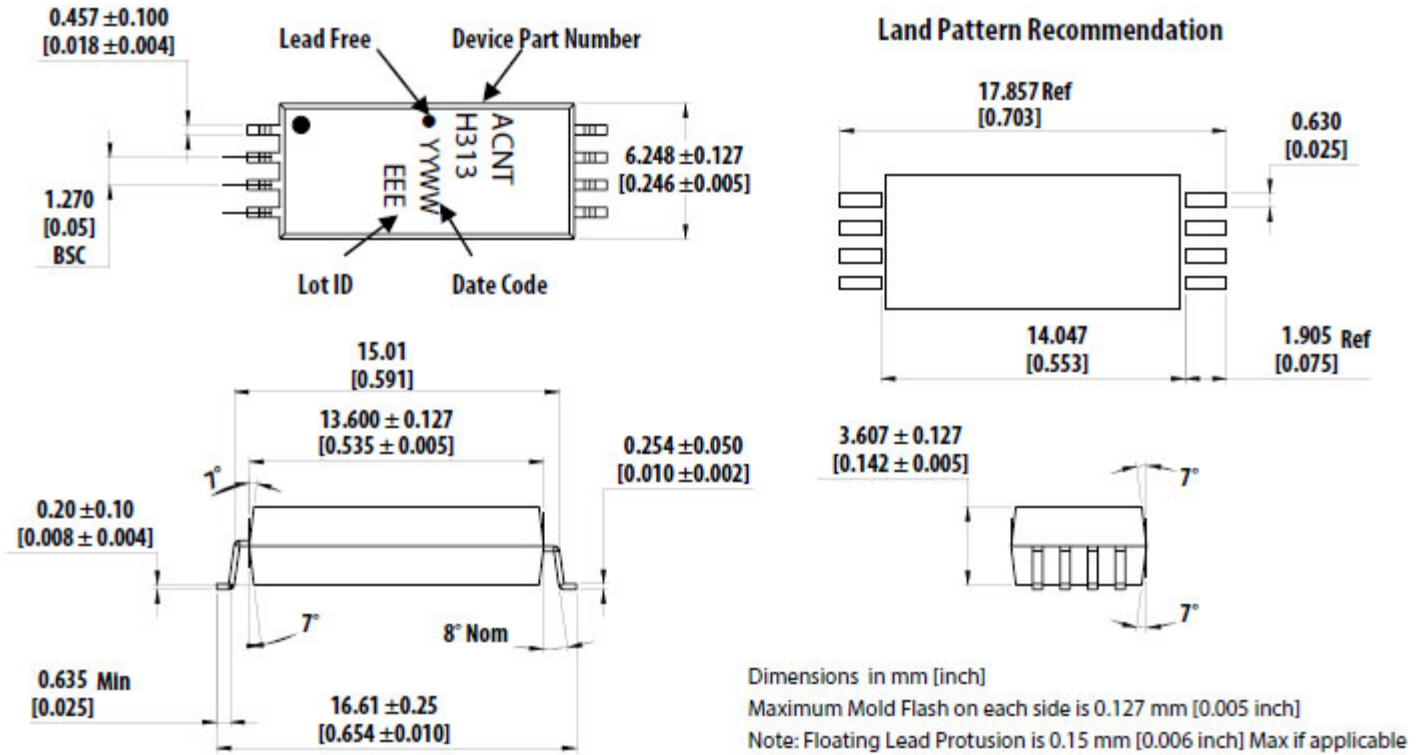

## Recommended Pb-Free IR Profile

Recommended reflow condition as per JEDEC Standard, J-STD-020 (latest revision). Non-halide flux should be used.

## Regulatory Information

The ACNT-H313 is approved by the following organizations.

<b>UL</b>	Recognized under UL 1577, component recognition program up to $V_{ISO} = 7500 V_{RMS}$ , File E55361
<b>CSA</b>	CSA Component Acceptance Notice #5, File CA 88324
<b>IEC/EN/DIN EN 60747-5-5</b>	Maximum Working Insulation Voltage $V_{IORM} = 2262 V_{PEAK}$

**Table 1. IEC/EN/DIN EN 60747-5-5 Insulation Characteristics (See Note)**

Description	Symbol	Characteristic	Units
Installation classification per DIN VDE 0110/39, Table 1 for rated mains voltage $\leq 600$ Vrms for rated mains voltage $\leq 1000$ Vrms		I-IV I-IV	
Climatic Classification		40/105/21	
Pollution Degree (DIN VDE 0110/39)		2	
Maximum Working Insulation Voltage	$V_{IORM}$	2262	$V_{PEAK}$
Input to Output Test Voltage, Method b <sup>a</sup> $V_{IORM} \times 1.875 = V_{PR}$ , 100% Production Test with $t_m = 1$ sec, Partial discharge $< 5$ pC	$V_{PR}$	4242	$V_{PEAK}$
Input to Output Test Voltage, Method a* $V_{IORM} \times 1.6 = V_{PR}$ , Type and Sample Test, $t_m = 10$ sec, Partial discharge $< 5$ pC	$V_{PR}$	3619	$V_{PEAK}$
Highest Allowable Overvoltage <sup>a</sup> Transient Overvoltage $t_{ini} = 60$ sec)	$V_{IOTM}$	12000	$V_{PEAK}$
Safety-limiting values – maximum values allowed in the event of a failure			
Case Temperature	$T_S$	175	$^{\circ}C$
Input Current	$I_{S, INPUT}$	230	mA
Output Power	$P_{S, OUTPUT}$	1000	mW
Insulation Resistance at $T_S$ , $V_{IO} = 500$ V	$R_S$	$>10^9$	$\Omega$

a. Refer to IEC/EN/DIN EN 60747-5-5 Optoisolator Safety Standard section of the *Broadcom Regulatory Guide to Isolation Circuits*, AV02-2041EN, for a detailed description of Method a and Method b partial discharge test profiles.

**NOTE:** These optocouplers are suitable for “safe electrical isolation” only within the safety limit data. Maintenance of the safety data shall be ensured by means of protective circuits. Surface mount classification is Class A in accordance with CECC 00802.

**Table 2. Insulation and Safety Related Specifications**

Parameter	Symbol	ACNT-H313	Units	Conditions
Minimum External Air Gap (Clearance)	L(101)	14.2	mm	Measured from input terminals to output terminals, shortest distance through air.
Minimum External Tracking (Creepage)	L(102)	15	mm	Measured from input terminals to output terminals, shortest distance path along body.
Minimum Internal Plastic Gap (Internal Clearance)		0.5	mm	Through insulation distance conductor to conductor, usually the straight line distance thickness between the emitter and detector.
Tracking Resistance (Comparative Tracking Index)	CTI	> 300	V	DIN IEC 112/VDE 0303 Part 1
Isolation Group		IIIa		Material Group (DIN VDE 0110, 1/89, Table 1)

All Broadcom data sheets report the creepage and clearance inherent to the optocoupler component itself. These dimensions are needed as a starting point for the equipment designer when determining the circuit insulation requirements. However, once mounted on a printed circuit board, minimum creepage and clearance requirements must be met as specified for individual equipment standards. For creepage, the shortest distance path along the surface of a printed circuit board between the solder fillets of the input and output leads must be considered (the recommended land pattern does not necessarily meet the minimum creepage of the device). There are recommended techniques such as grooves and ribs which may be used on a printed circuit board to achieve desired creepage and clearances. Creepage and clearance distances will also change depending on factors, such as pollution degree and insulation level.

**Table 3. Absolute Maximum Ratings**

Parameter	Symbol	Min.	Max.	Units	Note
Storage Temperature	$T_S$	-55	125	°C	
Operating Temperature	$T_A$	-40	105	°C	
Average Input Current	$I_{F(AVG)}$	—	25	mA	a
Reverse Input Voltage	$V_R$	—	5	V	
“High” Peak Output Current	$I_{OH(PEAK)}$	—	2.5	A	b
“Low” Peak Output Current	$I_{OL(PEAK)}$	—	2.5	A	b
Total Output Supply Voltage	$(V_{CC} - V_{EE})$	0	35	V	
Input Current (Rise/Fall Time)	$t_{r(IN)} / t_{f(IN)}$	—	500	ns	
Output Voltage	$V_{O(PEAK)}$	-0.5	$V_{CC}$	V	
Output IC Power Dissipation	$P_O$	—	800	mW	c
Total Power Dissipation	$P_T$	—	850	mW	d

- Derate linearly above 70°C free-air temperature at a rate of 0.3 mA/°C.
- Maximum pulse width = 10 ms. This value is intended to allow for component tolerances for designs with  $I_O$  peak minimum = 2.0A. See [Applications Information](#) for additional details on limiting  $I_{OH}$  peak.
- Derate linearly above 85°C free-air temperature at a rate of -20 mW/°C.
- Derate linearly above 85 °C free-air temperature at a rate of -21.25 mW/°C. The maximum LED junction temperature should not exceed 125°C.

**Table 4. Recommended Operating Conditions**

Parameter	Symbol	Min.	Max.	Units	Note
Operating Temperature	$T_A$	-40	105	°C	
Output Supply Voltage	$(V_{CC} - V_{EE})$	15	30	V	
Input Current (ON)	$I_{F(ON)}$	7	12	mA	
Input Voltage (OFF)	$V_{F(OFF)}$	-3.6	0.5	V	

**Table 5. Electrical Specifications (DC)**

All typical values are at  $T_A = 25^\circ\text{C}$ ,  $V_{CC} - V_{EE} = 30\text{V}$ ,  $V_{EE} = \text{Ground}$ . All minimum and maximum specifications are at recommended operating conditions ( $T_A = -40$  to  $105^\circ\text{C}$ ,  $I_{F(ON)} = 7$  mA to 12 mA,  $V_{F(OFF)} = -3.6$  to  $0.8$  V,  $V_{EE} = \text{Ground}$ ,  $V_{CC} = 15\text{V}$  to  $30\text{V}$ ), unless otherwise noted.

Parameter	Symbol	Min.	Typ.	Max.	Units	Test Conditions	Figure	Note
High Level Peak Output Current	$I_{OH}$	0.5	1.5	—	A	$V_O = V_{CC} - 4\text{V}$	2, 3, 16	a
		2.0	—	—	A	$V_O = V_{CC} - 15\text{V}$		b
Low Level Peak Output Current	$I_{OL}$	0.5	2.0	—	A	$V_O = V_{EE} + 2.5\text{V}$	5, 6, 17	a
		2.0	—	—	A	$V_O = V_{EE} + 15\text{V}$		b
High Level Output Voltage	$V_{OH}$	$V_{CC} - 4$	$V_{CC} - 3$	—	V	$I_O = -100$ mA	1, 3, 18	c, d
Low Level Output Voltage	$V_{OL}$	—	0.1	0.5	V	$I_O = 100$ mA	4, 6, 19	
High Level Supply Current	$I_{CCH}$	—	2.5	5.0	mA	Output Open, $I_F = 10$ mA	7, 8	
Low Level Supply Current	$I_{CCL}$	—	2.5	5.0	mA	Output Open, $V_F = -3.6\text{V}$ to $0.8\text{V}$		
Threshold Input Current Low to High	$I_{FLH}$	—	1.0	5.0	mA	$I_O = 0$ mA, $V_O > 5\text{V}$	9, 15, 20	
Threshold Input Voltage High to Low	$V_{FHL}$	0.5	—	—	V			
Input Forward Voltage	$V_F$	1.2	1.45	1.8	V	$I_F = 10$ mA		
Temperature Coefficient of Input Forward Voltage	$\Delta V_F / \Delta T_A$	—	-1.5	—	mV/°C	$I_F = 10$ mA		
Input Reverse Breakdown Voltage	$BV_R$	3	—	—	V	$I_R = 100$ $\mu\text{A}$		
Input Capacitance	$C_{IN}$		23	—	pF	$f = 1$ MHz, $V_F = 0\text{V}$		
UVLO Threshold	$V_{UVLO+}$	11.0	12.3	13.5	V	$V_O > 5\text{V}$ , $I_F = 10$ mA	21	
	$V_{UVLO-}$	9.5	10.7	12.0				
UVLO Hysteresis	$UVLO_{HYS}$	—	1.6	—				

- Maximum pulse width = 50 ms.
- Maximum pulse width = 10 ms. This value is intended to allow for component tolerances for designs with  $I_O$  peak minimum = 2.0A. See applications section for additional details on limiting  $I_{OH}$  peak.
- In this test,  $V_{OH}$  is measured with a DC load current. When driving capacitive loads,  $V_{OH}$  will approach  $V_{CC}$  as  $I_{OH}$  approaches 0A.
- Maximum pulse width = 1 ms.

## Table 6. Switching Specifications (AC)

All typical values are at  $T_A = 25^\circ\text{C}$ ,  $V_{CC} - V_{EE} = 30\text{V}$ ,  $V_{EE} = \text{Ground}$ . All minimum and maximum specifications are at recommended operating conditions ( $T_A = -40$  to  $105^\circ\text{C}$ ,  $I_{F(\text{ON})} = 7$  mA to 12 mA,  $V_{F(\text{OFF})} = -3.6$  to 0.8 V,  $V_{EE} = \text{Ground}$ ,  $V_{CC} = 15\text{V}$  to  $30\text{V}$ ), unless otherwise noted.

Parameter	Symbol	Min.	Typ.	Max.	Units	Test Conditions	Figure	Note
Propagation Delay Time to High Output Level	$t_{\text{PLH}}$	0.10	0.28	0.50	$\mu\text{s}$	$R_g = 10\ \Omega$ , $C_g = 10\ \text{nF}$ , $f = 10\ \text{kHz}$ , Duty Cycle = 50%, $I_F = 7\ \text{mA}$ to $12\ \text{mA}$ , $V_{CC} = 15\text{V}$ to $30\text{V}$	10, 11, 12, 13, 14, 22	
Propagation Delay Time to Low Output Level	$t_{\text{PHL}}$	0.10	0.30	0.50	$\mu\text{s}$			
Pulse Width Distortion	PWD	—	—	0.30	$\mu\text{s}$			a
Propagation Delay Difference Between Any Two Parts	PDD ( $t_{\text{PHL}} - t_{\text{PLH}}$ )	-0.35	—	0.35	$\mu\text{s}$			b
Propagation Delay Skew	$t_{\text{PSK}}$	—	—	0.20	$\mu\text{s}$			c
Rise Time	$t_R$	—	0.10	—	$\mu\text{s}$		22	
Fall Time	$t_F$	—	0.10	—	$\mu\text{s}$			
UVLO Turn On Delay	$t_{\text{UVLO ON}}$	—	0.80	—	$\mu\text{s}$	$V_O > 5\text{V}$ , $I_F = 10\ \text{mA}$	21	
UVLO Turn Off Delay	$t_{\text{UVLO OFF}}$	—	0.60	—	$\mu\text{s}$	$V_O < 5\text{V}$ , $I_F = 10\ \text{mA}$		
Output High Level Common Mode Transient Immunity	$ CM_H $	40	50	—	$\text{kV}/\mu\text{s}$	$T_A = 25^\circ\text{C}$ , $I_F = 10\ \text{mA}$ , $V_{CM} = 2000\text{V}$ , $V_{CC} = 30\text{V}$	23	d, e
Output Low Level Common Mode Transient Immunity	$ CM_L $	40	50	—	$\text{kV}/\mu\text{s}$	$T_A = 25^\circ\text{C}$ , $V_F = 0\text{V}$ , $V_{CM} = 2000\text{V}$ , $V_{CC} = 30\text{V}$		d, f

- Pulse Width Distortion (PWD) is defined as  $|t_{\text{PHL}} - t_{\text{PLH}}|$  for any given device.
- The difference between  $t_{\text{PHL}}$  and  $t_{\text{PLH}}$  between any two ACNT-H313 parts under the same test condition.
- $t_{\text{PSK}}$  is equal to the worst-case difference in  $t_{\text{PHL}}$  or  $t_{\text{PLH}}$  that will be seen between units at any given temperature and specified test conditions.
- Pins 1 and 4 must be connected to LED common. Split resistor network in the ratio 1.5:1 with 215W at the anode and 140W at the cathode.
- Common mode transient immunity in the high state is the maximum tolerable  $dV_{CM}/dt$  of the common mode pulse,  $V_{CM}$ , to assure that the output will remain in the high state (that is,  $V_O > 15.0\text{V}$ ).
- Common mode transient immunity in a low state is the maximum tolerable  $dV_{CM}/dt$  of the common mode pulse,  $V_{CM}$ , to assure that the output will remain in a low state (that is,  $V_O < 1.0\text{V}$ ).

## Table 7. Package Characteristics

All typical values are at  $T_A = 25^\circ\text{C}$ . All minimum/maximum specifications are at recommended operating conditions, unless otherwise noted.

Parameter	Symbol	Min.	Typ.	Max.	Units	Test Conditions	Figure	Note
Input-Output Momentary Withstand Voltage <sup>a</sup>	$V_{ISO}$	7500	—	—	$V_{RMS}$	RH < 50%, t = 1 min., $T_A = 25^\circ\text{C}$		b, c
Input-Output Resistance	$R_{I-O}$	—	$10^{12}$	—	$\Omega$	$V_{I-O} = 500 V_{DC}$		c
Input-Output Capacitance	$C_{I-O}$	—	0.5	—	pF	f = 1 MHz		
LED-to-Ambient Thermal Resistance	$R_{11}$	—	87	—	$^\circ\text{C/W}$	See <a href="#">Thermal Model</a>		d
LED-to-Detector Thermal Resistance	$R_{12}$	—	23	—				
Detector-to-LED Thermal Resistance	$R_{21}$	—	30	—				
Detector-to-Ambient Thermal Resistance	$R_{22}$	—	47	—				

- The Input-Output Momentary Withstand Voltage is a dielectric voltage rating that should not be interpreted as an input-output continuous voltage rating. For the continuous voltage rating, refer to your equipment level safety specification or Broadcom Application Note 1074, *Optocoupler Input-Output Endurance Voltage*.
- In accordance with UL1577, each optocoupler is proof tested by applying an insulation test voltage  $\geq 9000 V_{RMS}$  for 1 second (leakage detection current limit,  $I_{I-O} \leq 5 \mu\text{A}$ ).
- The device is considered to be a two-terminal device: pins 1, 2, 3, and 4 shorted together and pins 5, 6, 7, and 8 shorted together.
- The device was mounted on a high conductivity test board as per JEDEC 51-7.



Figure 1:  $V_{OH}$  vs. Temperature

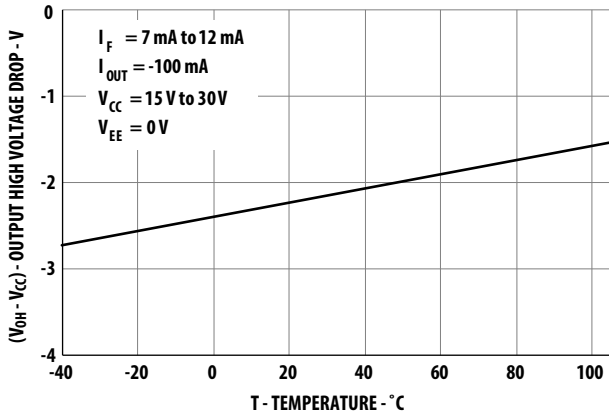

Figure 2:  $I_{OH}$  vs. Temperature

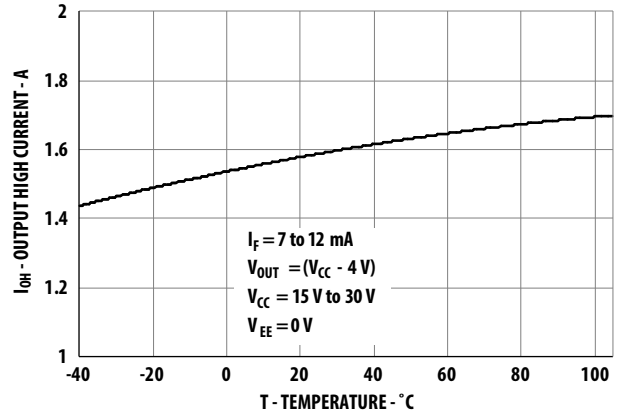

Figure 3:  $I_{OH}$  vs.  $V_{OH}$

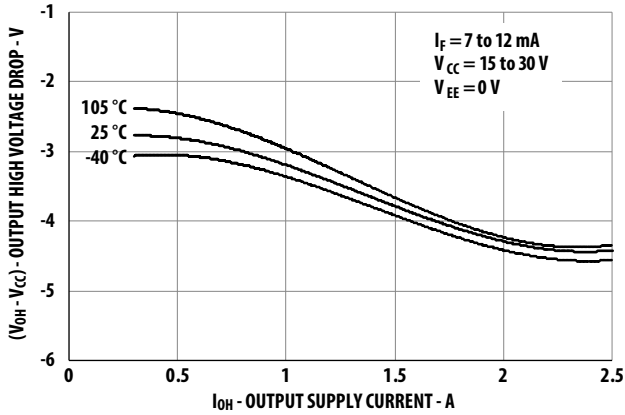

Figure 4:  $V_{OL}$  vs. Temperature

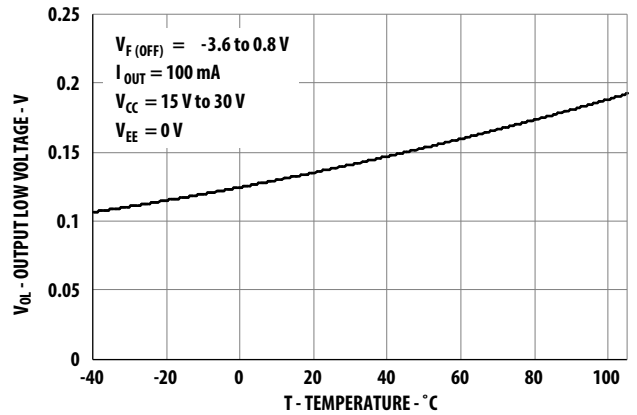

Figure 5:  $I_{OL}$  vs. Temperature

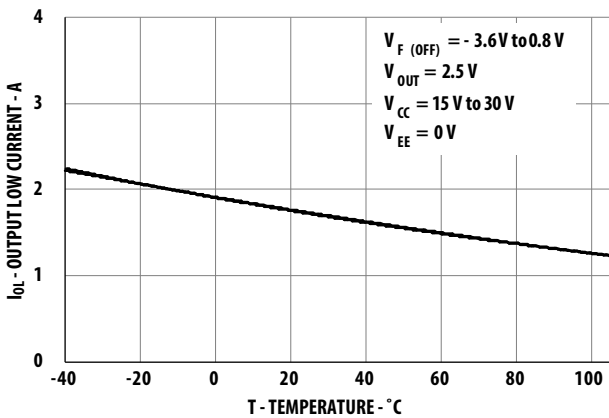

Figure 6:  $V_{OL}$  vs.  $I_{OL}$

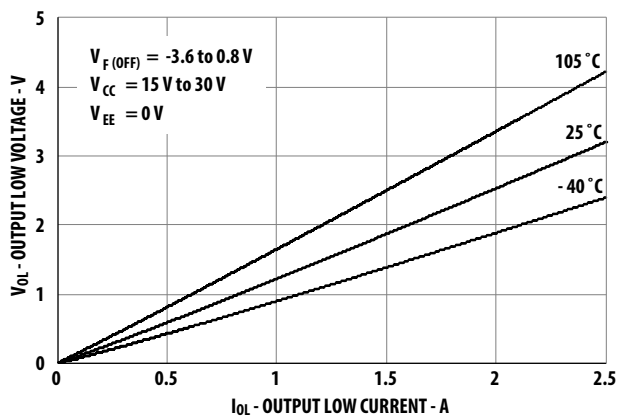

Figure 7:  $I_{CC}$  vs. Temperature

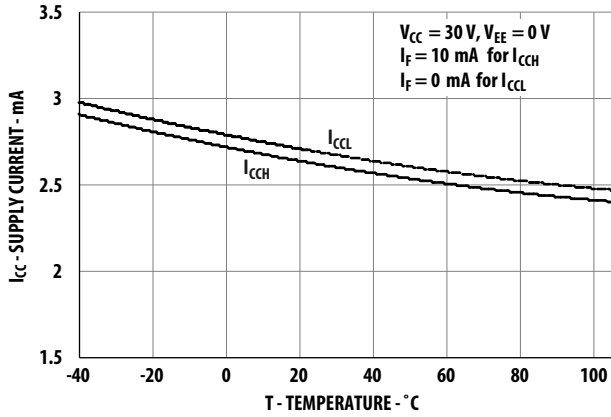

Figure 8:  $I_{CC}$  vs.  $V_{CC}$

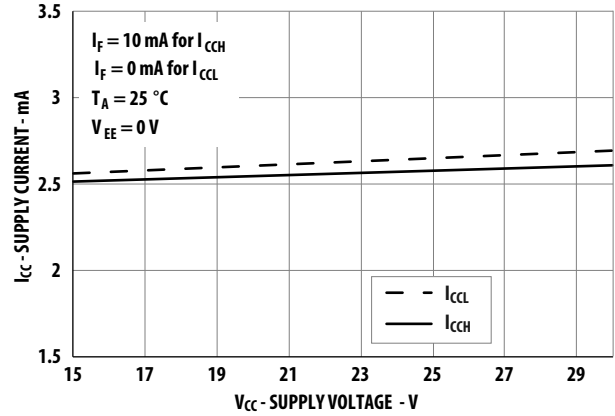

Figure 9:  $I_{FLH}$  vs. Temperature

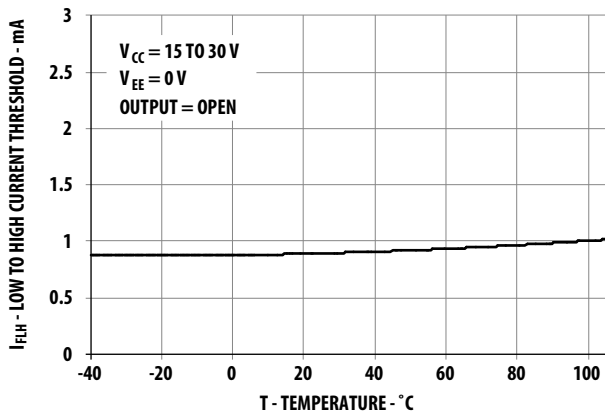

Figure 10: Propagation Delay s.  $V_{CC}$

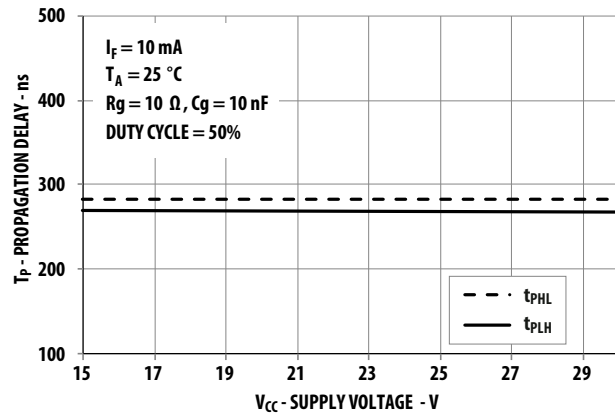

Figure 11: Propagation Delay vs.  $I_F$

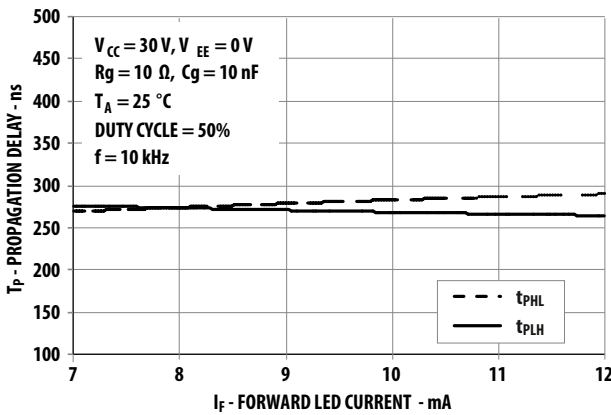

Figure 12: Propagation Delay vs. Temperature

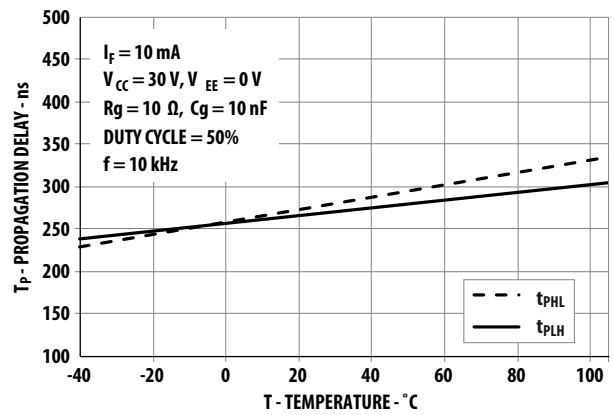

Figure 13: Propagation Delay vs. Rg

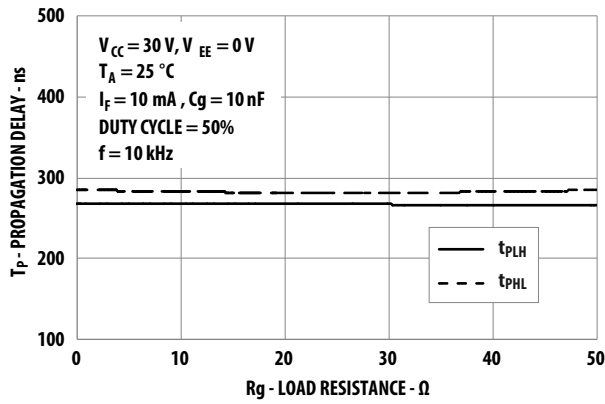

Figure 14: Propagation Delay vs. Cg

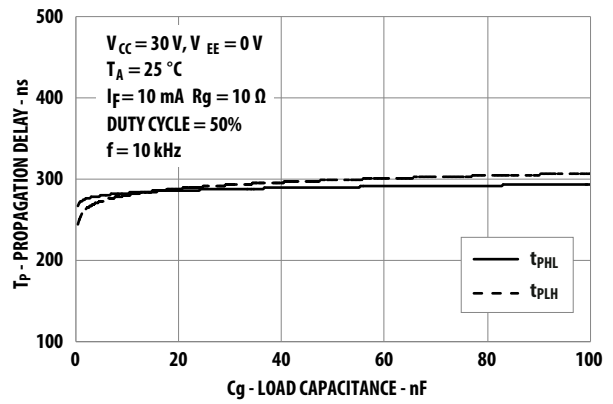

Figure 15: Transfer Characteristics

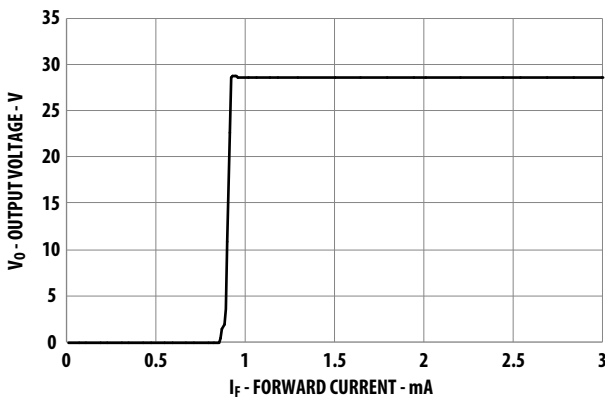

Figure 16: IOL Test Circuit

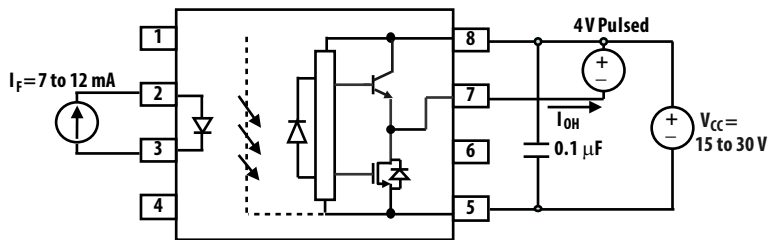

Figure 17:  $I_{OH}$  Test Circuit

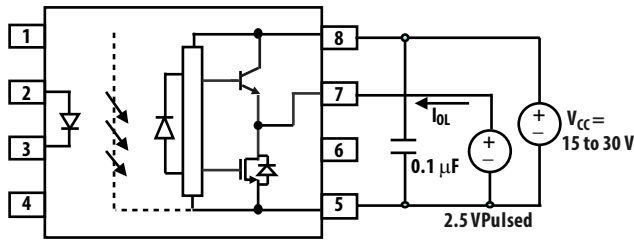

Figure 18:  $V_{OH}$  Test Circuit

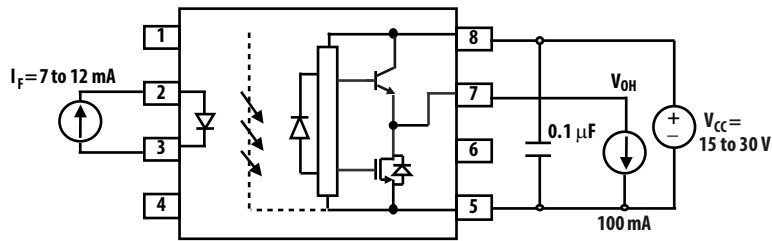

Figure 19:  $V_{OL}$  Test Circuit

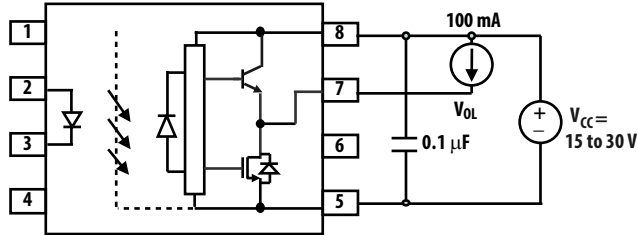

Figure 20:  $I_{FLH}$  Test Circuit

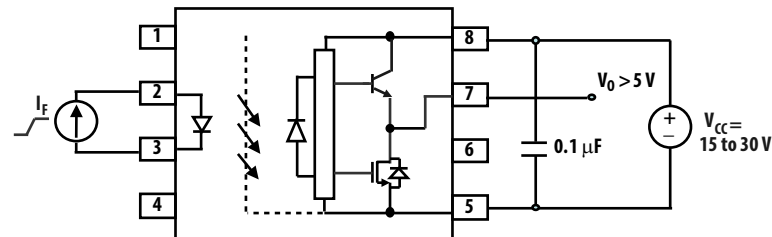

Figure 21: ULVO Test Circuit

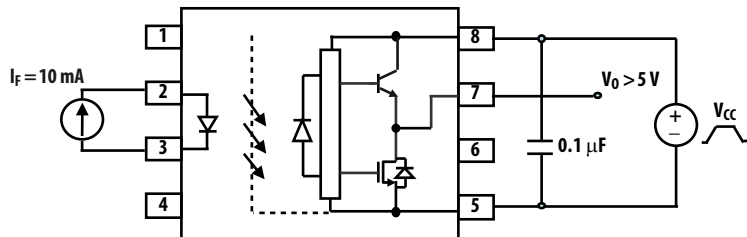

Figure 22: TPLH, tPHL, Tr and tf Test Circuit and Waveforms

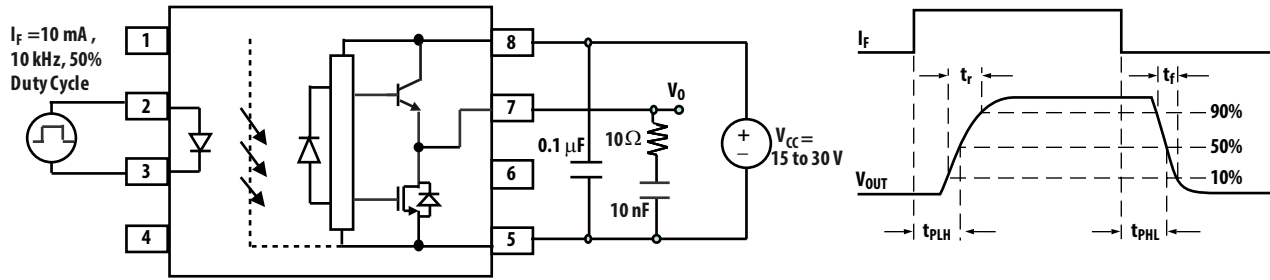
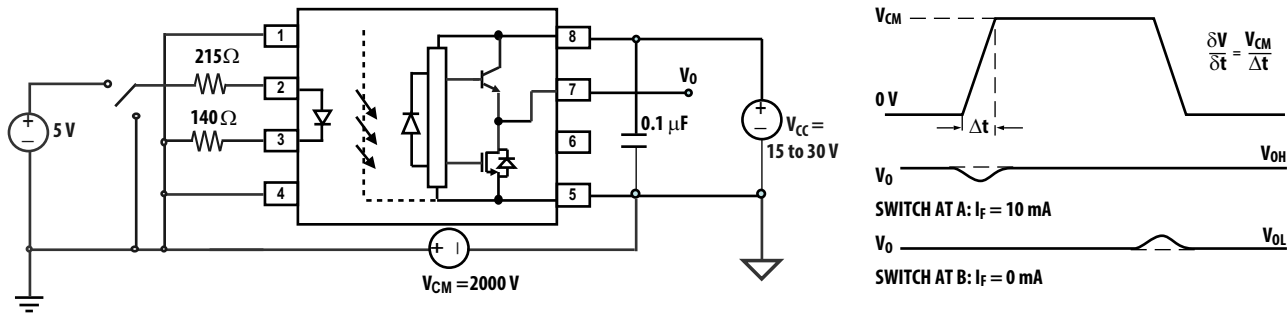

Figure 23: CMR Test Circuit and Waveforms



## Applications Information

### Selecting the Gate Resistor ( $R_g$ ) to Minimize IGBT Switching Losses

**Step 1: Calculate  $R_g$  minimum from the IOL peak specification.** The IGBT and  $R_g$  in [Figure 24](#) can be analyzed as a simple RC circuit with a voltage supplied by the ACNT-H313.

$$\begin{aligned} R_g &\geq \frac{V_{CC} - V_{EE} - V_{OL}}{I_{OLPEAK}} \\ &= \frac{15 + 5 - 2}{2.5} \\ &= 7.2 \Omega \cong 8 \Omega \end{aligned}$$

The  $V_{OL}$  value of 2V in the previous equation is a conservative value of  $V_{OL}$  at the peak current of 2.5A (see [Figure 6](#)). At lower  $R_g$  values, the voltage supplied by the ACNT-H313 is not an ideal voltage step. This results in lower peak currents (more margin) than predicted by this analysis. When negative gate drive is not used  $V_{EE}$  in the previous equation is equal to 0V.

**Figure 24: ACNT-H313 Typical Application Circuit**

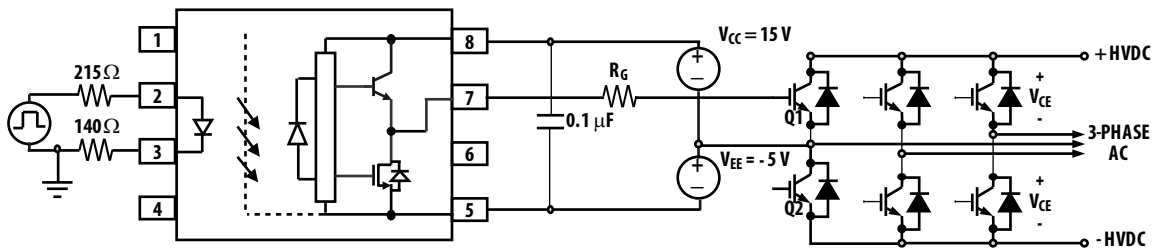

**Step 2: Check the ACNT-H313 Power Dissipation and Increase  $R_g$  if necessary.** The ACNT-H313 total power dissipation ( $P_T$ ) is equal to the sum of the emitter power ( $P_E$ ) and the output power ( $P_O$ ).

$$P_T = P_E + P_O$$

$$P_E = I_F \cdot V_F \cdot \text{DutyCycle}$$

$$P_O = P_{O(\text{BIAS})} + P_{O(\text{SWITCHING})} = I_{CC} \cdot V_{CC} + E_{SW}(R_g, Q_g) \cdot f$$

$P_E$ Parameter	Description
$I_F$	LED current
$V_F$	LED-on voltage
Duty Cycle	Maximum LED duty cycle

$P_O$ Parameter	Description
$I_{CC}$	Supply current
$V_{CC}$	Positive supply voltage
$V_{EE}$	Negative supply voltage
$E_{SW}(R_g, Q_g)$	Energy dissipated in the ACNT-H313 for each IGBT switching cycle (see <a href="#">Figure 25</a> )
$f$	Switching frequency

For the circuit in [Figure 24](#) with  $I_F$  (worst case) = 12 mA,  $R_g = 8\Omega$ , Maximum Duty Cycle = 80%,  $Q_g = 500$  nC,  $f = 20$  kHz, and  $T_A$  maximum = 85°C.

$$P_F = 12 \text{ mA} \cdot 1.8 \text{ V} \cdot 0.8 = 17.3 \text{ mW}$$

$$P_O = 4.25 \text{ mA} \cdot 20 \text{ V} + 5.2 \mu\text{J} \cdot 20 \text{ kHz}$$

$$= 85 \text{ mW} + 104 \text{ mW}$$

$$= 189 \text{ mW}$$

$$< 800 \text{ mW (} P_{O(\text{MAX})} \text{ @ } 85^\circ\text{C)}$$

The value of 4.25 mA for  $I_{CC}$  in the previous equation was obtained by derating the  $I_{CC}$  maximum of 5 mA (which occurs at -40°C) to  $I_{CC}$  max at 85°C (see [Figure 7](#)).

Because  $P_O$  for this case is smaller than  $P_{O(\text{MAX})}$ ,  $R_g$  of 8Ω can be used.

**Figure 25: Energy Dissipated in the ACNT-H313 for Each IGBT Switching Cycle**

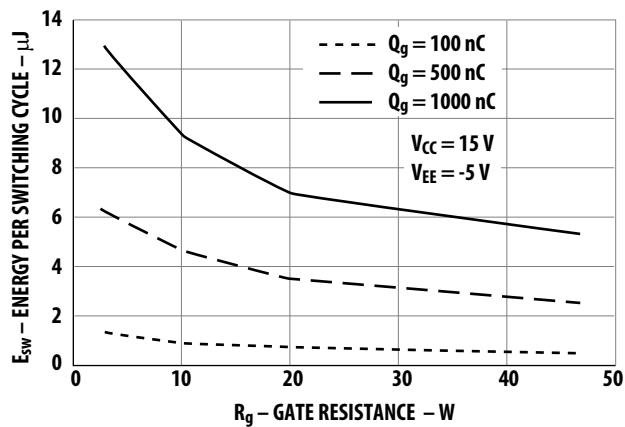

## Thermal Model

### Definitions

$R_{11}$	Junction-to-Ambient Thermal Resistance of LED due to heating of LED
$R_{12}$	Junction-to-Ambient Thermal Resistance of LED due to heating of Detector (Output IC)
$R_{21}$	Junction-to-Ambient Thermal Resistance of Detector (Output IC) due to heating of LED
$R_{22}$	Junction-to-Ambient Thermal Resistance of Detector (Output IC) due to heating of Detector (Output IC)
$P_1$	Power dissipation of LED (W)
$P_2$	Power dissipation of Detector/Output IC (W)
$T_1$	Junction temperature of LED (°C)
$T_2$	Junction temperature of Detector (°C)
$T_A$	Ambient temperature

Ambient Temperature: Junction-to-Ambient Thermal Resistances were measured approximately 1.25 cm above the optocoupler at ~23°C in still air.

Thermal Resistance	°C/W
$R_{11}$	87
$R_{12}$	23
$R_{21}$	30
$R_{22}$	47

This thermal model assumes the device is soldered onto a high conductivity board as per JEDEC 51-7. The temperature at the LED and Detector junctions of the optocoupler can be calculated using the following equations:

$$T_1 = (R_{11} \times P_1 + R_{12} \times P_2) + T_A \text{ -- (1)}$$

$$T_2 = (R_{21} \times P_1 + R_{22} \times P_2) + T_A \text{ -- (2)}$$

Using the given thermal resistances and thermal model formula in this data sheet, we can calculate the junction temperature for both LED and the output detector. Both junction temperatures should be within the absolute maximum rating of 125°C.

### Related Documents

AV02-0421EN	Application Note 5336	<i>Gate Drive Optocoupler Basic Design for IGBT / MOSFET</i>
AV02-3698EN	Application Note 1043	<i>Common-Mode Noise: Sources and Solutions</i>
AV02-0310EN	Reliability Data	<i>Plastics Optocouplers Product ESD and Moisture Sensitivity</i>



Broadcom, the pulse logo, Connecting everything, Avago Technologies, Avago, and the A logo are among the trademarks of Broadcom and/or its affiliates in the United States, certain other countries, and/or the EU.

Copyright © 2016–2020 Broadcom. All Rights Reserved.

The term “Broadcom” refers to Broadcom Inc. and/or its subsidiaries. For more information, please visit [www.broadcom.com](http://www.broadcom.com).

Broadcom reserves the right to make changes without further notice to any products or data herein to improve reliability, function, or design. Information furnished by Broadcom is believed to be accurate and reliable. However, Broadcom does not assume any liability arising out of the application or use of this information, nor the application or use of any product or circuit described herein, neither does it convey any license under its patent rights nor the rights of others.



# Mouser Electronics

Authorized Distributor

Click to View Pricing, Inventory, Delivery & Lifecycle Information:

[Broadcom Limited:](#)

[ACNT-H313-500E](#) [ACNT-H313-000E](#)