

## 4 MHz PWM 400 mA Buck Regulator with HyperLight Load<sup>®</sup>

### Features

- Input Voltage: 2.7V to 5.5V
- 400 mA Output Current
- Up to 93% Efficiency and 88% at 1 mA
- 21  $\mu$ A Typical Quiescent Current
- 4 MHz PWM Operation in Continuous Mode
- Ultra-Fast Transient Response
- Low Voltage Output Ripple
  - 20 mV<sub>PP</sub> Ripple in HyperLight Load<sup>®</sup> Mode
  - 3 mV Output Voltage Ripple in Full PWM Mode
- 0.01  $\mu$ A Shutdown Current
- MIC23031 Fixed and Adjustable Output Voltage Options Available
- 1.6 mm x 1.6 mm 6-Lead TDFN Package
- -40°C to +125°C Junction Temperature Range

### Applications

- Mobile Handsets
- Portable Media/MP3 Players
- Portable Navigation Devices (GPS)
- WiFi/WiMax/WiBro Modules
- Digital Cameras
- Wireless LAN Cards
- USB-Powered Devices
- Portable Applications

### General Description

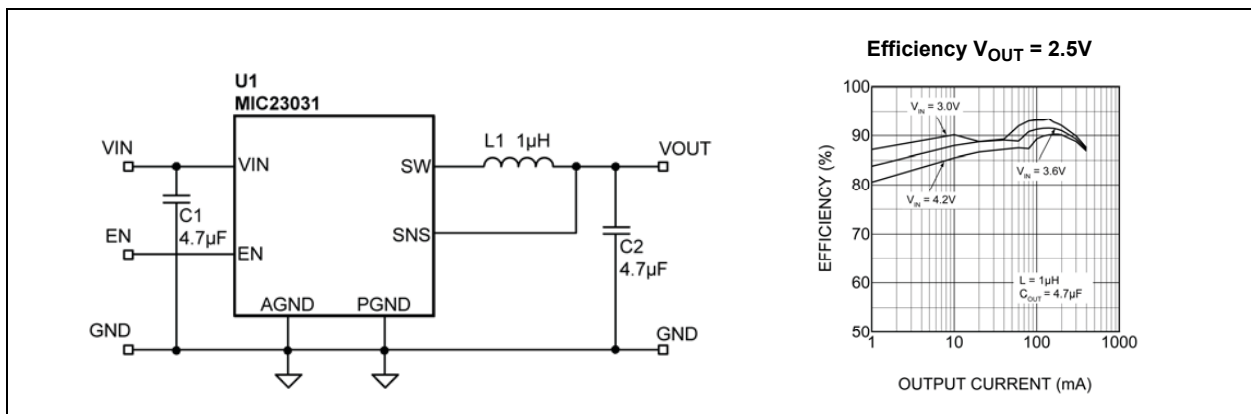
The MIC23031 is a high-efficiency, 4 MHz, 400 mA synchronous buck regulator with HyperLight Load<sup>®</sup> mode. HyperLight Load provides very high efficiency at light loads and ultra-fast transient response that is perfectly suited for supplying processor core voltages. An additional benefit of this proprietary architecture is the very low output ripple voltage throughout the entire load range with the use of small output capacitors. The tiny 1.6 mm x 1.6 mm TDFN package saves precious board space and requires only three external components.

The MIC23031 is designed for use with a very small inductor, down to 0.47  $\mu$ H, and an output capacitor as small as 2.2  $\mu$ F that enables a sub 1 mm height.

The MIC23031 has a very low quiescent current of 21  $\mu$ A and achieves as high as 88% efficiency at 1 mA. At higher loads, the MIC23031 provides a constant switching frequency around 4 MHz while achieving peak efficiencies up to 93%.

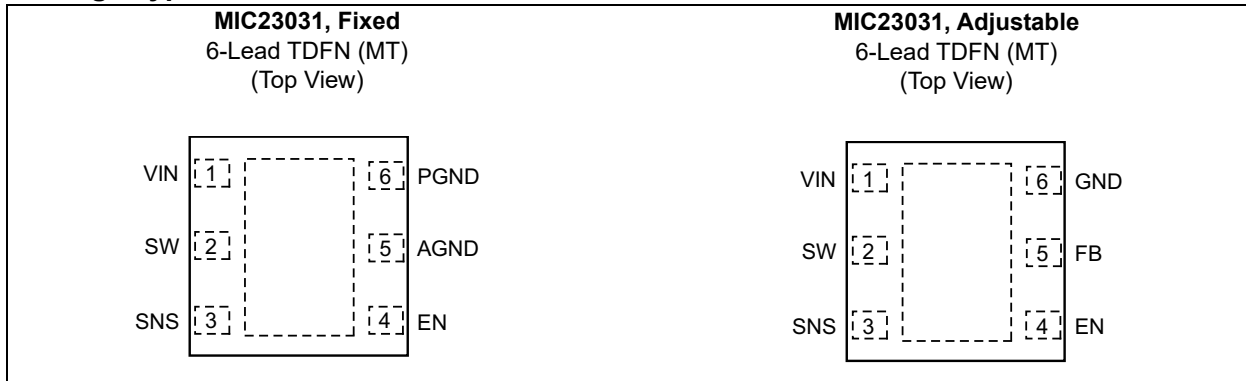
The MIC23031 is available in a 6-pin 1.6 mm x 1.6 mm TDFN package with an operating junction temperature range of -40°C to +125°C.

### Typical Application Circuit

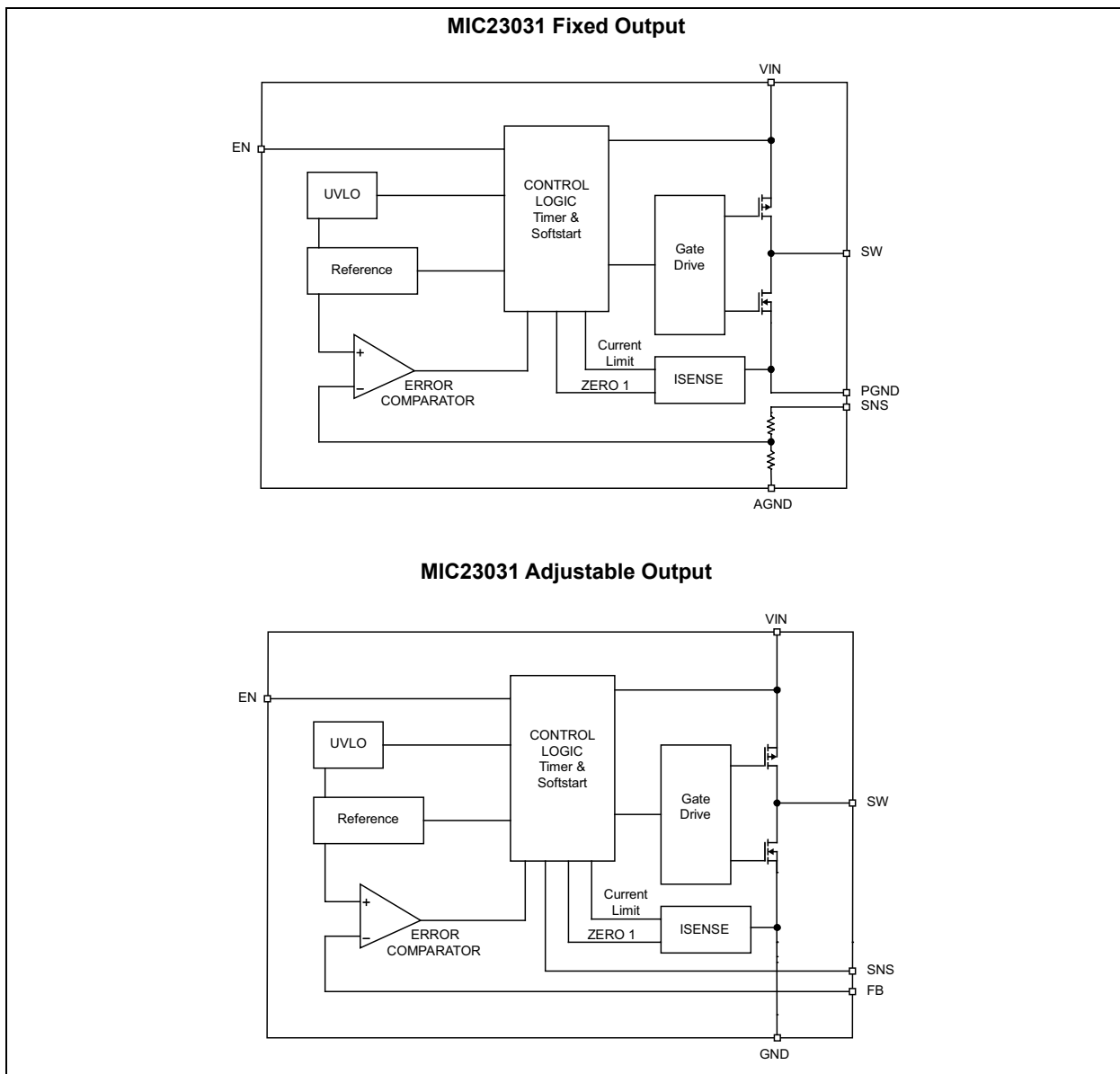


# MIC23031

## Package Types



## Functional Block Diagrams



## 1.0 ELECTRICAL CHARACTERISTICS

### Absolute Maximum Ratings †

Supply Voltage ( $V_{IN}$ ) .....	+6V
Sense ( $V_{SNS}$ ) .....	+6V
Output Switch Voltage .....	+6V
Enable Input Voltage ( $V_{EN}$ ) .....	-0.3V to $V_{IN}$
ESD Rating (Note 1) .....	ESD Sensitive

### Operating Ratings ‡

Supply Voltage ( $V_{IN}$ ) .....	+2.7V to +5.5V
Enable Input Voltage ( $V_{EN}$ ) .....	0V to $V_{IN}$
Output Voltage Range ( $V_{SNS}$ ) .....	+0.7V to +3.6V

† **Notice:** Stresses above those listed under “Absolute Maximum Ratings” may cause permanent damage to the device. This is a stress rating only and functional operation of the device at those or any other conditions above those indicated in the operational sections of this specification is not intended. Exposure to maximum rating conditions for extended periods may affect device reliability. Specifications are for packaged product only.

‡ **Notice:** The device is not guaranteed to function outside its operating ratings.

**Note 1:** Devices are ESD sensitive. Handling precautions are recommended. Human body model, 1.5 k $\Omega$  in series with 100 pF.

## ELECTRICAL CHARACTERISTICS

**Electrical Characteristics:**  $T_A = 25^\circ\text{C}$ ,  $L = 1.0 \mu\text{H}$ ,  $V_{IN} = V_{EN} = 3.6\text{V}$ ;  $C_{OUT} = 4.7 \mu\text{F}$ ; **Bold** values indicate  $-40^\circ\text{C} \leq T_J \leq +125^\circ\text{C}$ ; unless otherwise specified. Specification for packaged product only.

Parameter	Symbol	Min.	Typ.	Max.	Units	Conditions
Supply Voltage Range	$V_{IN}$	2.7	—	5.5	V	—
Undervoltage Lockout Threshold	$V_{UVLO}$	<b>2.45</b>	2.55	<b>2.65</b>	V	Turn-On
Quiescent Current	$I_Q$	—	21	35	$\mu\text{A}$	$I_{OUT} = 0 \text{ mA}$ , $V_{SNS} > 1.2 * V_{OUT(NOM)}$
Shutdown Current	$I_{SD}$	—	0.01	<b>4</b>	$\mu\text{A}$	$V_{EN} = 0\text{V}$ ; $V_{IN} = 5.5\text{V}$
Output Voltage Accuracy	$V_{OUT}$	<b>-2.5</b>	—	<b>+2.5</b>	%	$V_{IN} = 3.6\text{V}$ ; $I_{LOAD} = 20 \text{ mA}$
Feedback Voltage	$V_{FB}$	—	0.62	—	V	Adjustable Option Only
Current Limit	$I_{LIM}$	<b>0.41</b>	0.7	<b>1</b>	A	$V_{SNS} = 0.9 * V_{OUT(NOM)}$
Output Voltage Line Regulation	LINE_REG	—	0.3	—	%/V	$V_{IN} = 3.0\text{V}$ to $5.5\text{V}$ , $V_{OUT} = 1.2\text{V}$ , $I_{LOAD} = 20 \text{ mA}$ ,
Output Voltage Load Regulation	LOAD_REG	—	0.7	—	%	$20 \text{ mA} < I_{LOAD} < 400 \text{ mA}$ , $V_{OUT} = 1.2\text{V}$ , $V_{IN} = 3.6\text{V}$
PWM Switch On-Resistance	$R_{DS(ON)}$	—	0.65	—	$\Omega$	$I_{SW} = 100 \text{ mA PMOS}$
		—	0.8	—		$I_{SW} = -100 \text{ mA NMOS}$
Maximum Frequency	$F_{MAX}$	—	4	—	MHz	$I_{OUT} = 120 \text{ mA}$
Soft-Start Time	$t_{SS}$	—	100	—	$\mu\text{s}$	$V_{OUT} = 90\%$
Enable Threshold	$V_{EN}$	<b>0.5</b>	0.9	<b>1.2</b>	V	—
Enable Input Current	$I_{EN}$	—	0.1	<b>2</b>	$\mu\text{A}$	—
Overtemperature Shutdown	$T_{SD}$	—	160	—	$^\circ\text{C}$	—
Overtemperature Shutdown Hysteresis	$T_{SD\_HYS}$	—	20	—	$^\circ\text{C}$	—

# MIC23031

---

---

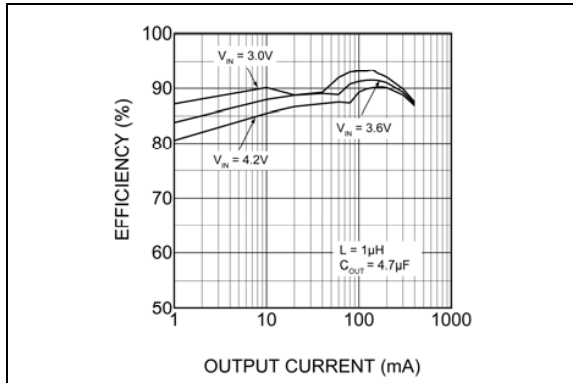
## TEMPERATURE SPECIFICATIONS (Note 1)

Parameters	Symbol	Min.	Typ.	Max.	Units	Conditions
<b>Temperature Ranges</b>						
Junction Operating Temperature Range	$T_J$	-40	—	+125	°C	—
Storage Temperature Range	$T_S$	-65	—	+150	°C	—
<b>Package Thermal Resistances</b>						
Thermal Resistance TDFN 1.6 mm x 1.6 mm	$\theta_{JA}$	—	92.4	—	°C/W	—

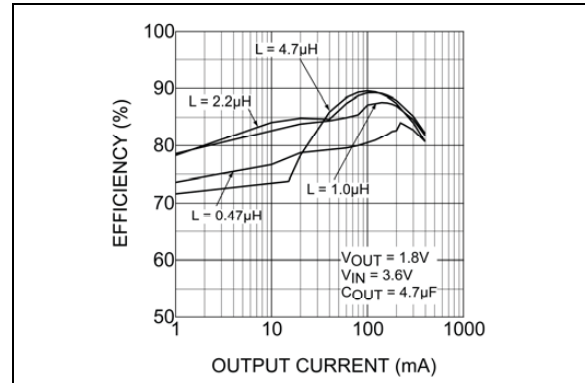
**Note 1:** The maximum allowable power dissipation is a function of ambient temperature, the maximum allowable junction temperature and the thermal resistance from junction to air (i.e.,  $T_A$ ,  $T_J$ ,  $\theta_{JA}$ ). Exceeding the maximum allowable power dissipation will cause the device operating junction temperature to exceed the maximum +125°C rating. Sustained junction temperatures above +125°C can impact the device reliability.

## 2.0 TYPICAL PERFORMANCE CURVES

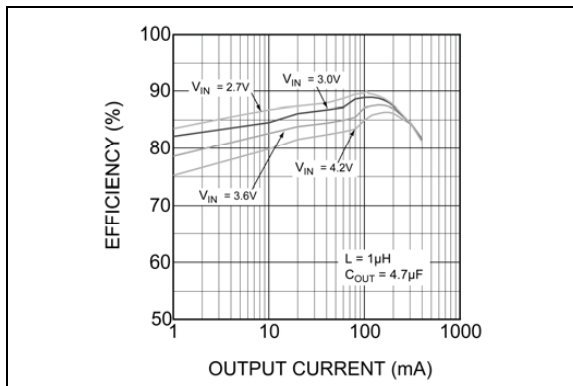
**Note:** The graphs and tables provided following this note are a statistical summary based on a limited number of samples and are provided for informational purposes only. The performance characteristics listed herein are not tested or guaranteed. In some graphs or tables, the data presented may be outside the specified operating range (e.g., outside specified power supply range) and therefore outside the warranted range.



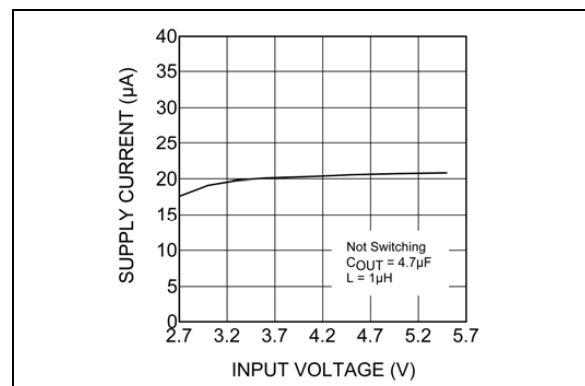
**FIGURE 2-1:** Efficiency ( $V_{OUT} = 2.5V$ ).



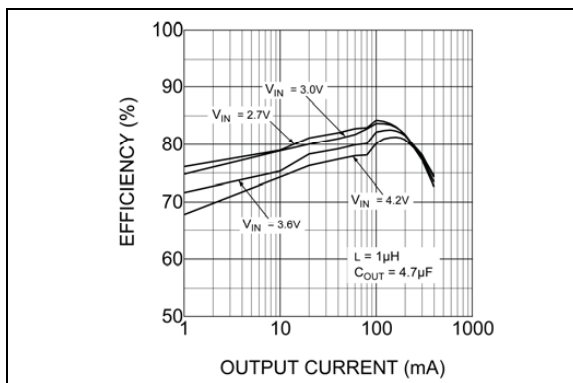
**FIGURE 2-4:** Efficiency with Various Inductors.



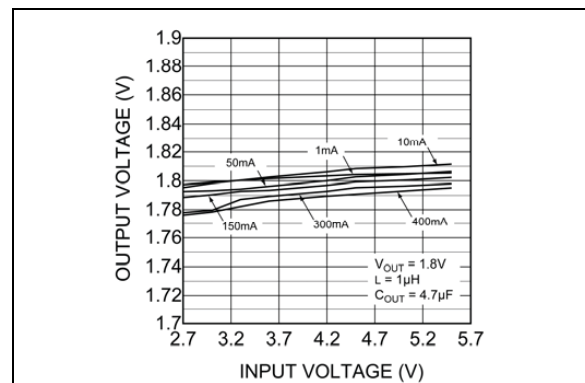
**FIGURE 2-2:** Efficiency ( $V_{OUT} = 1.8V$ ).



**FIGURE 2-5:** Quiescent Current vs. Input Voltage.

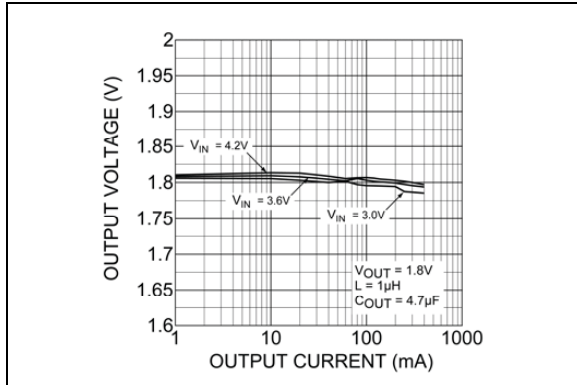


**FIGURE 2-3:** Efficiency ( $V_{OUT} = 1.2V$ ).

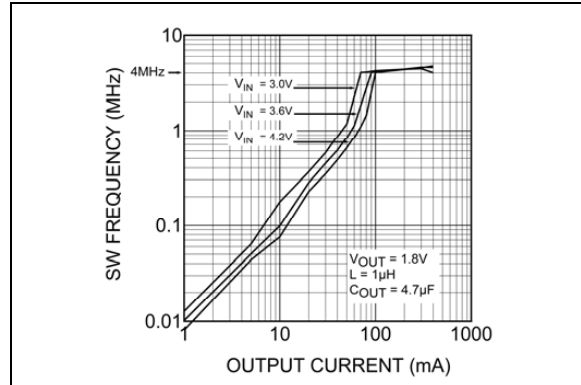


**FIGURE 2-6:** Output Voltage vs. Input Voltage.

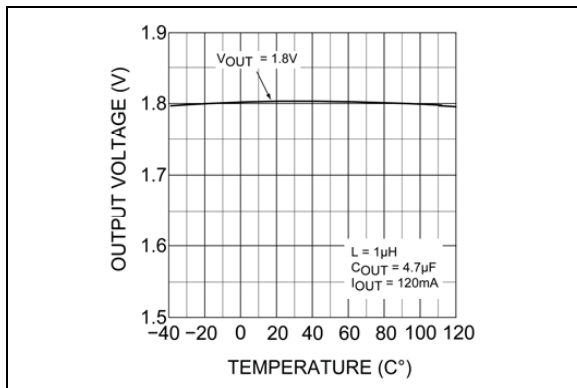
# MIC23031



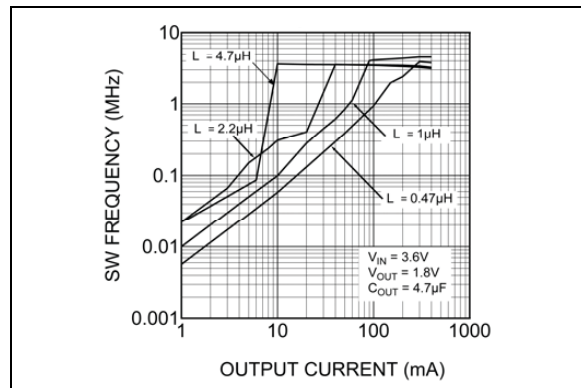
**FIGURE 2-7:** Output Voltage vs. Output Current.



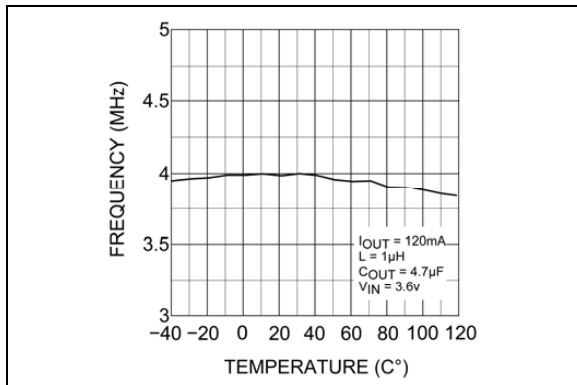
**FIGURE 2-10:** Switching Frequency vs. Output Current.



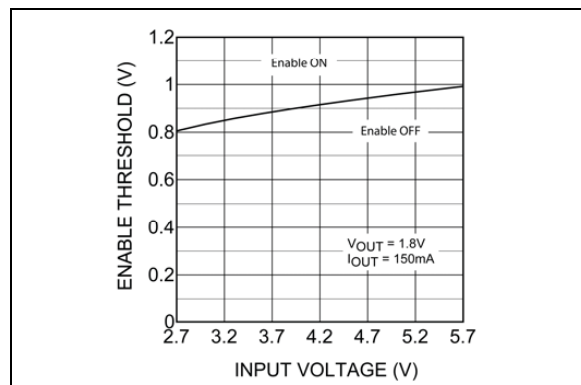
**FIGURE 2-8:** Output Voltage vs. Temperature.



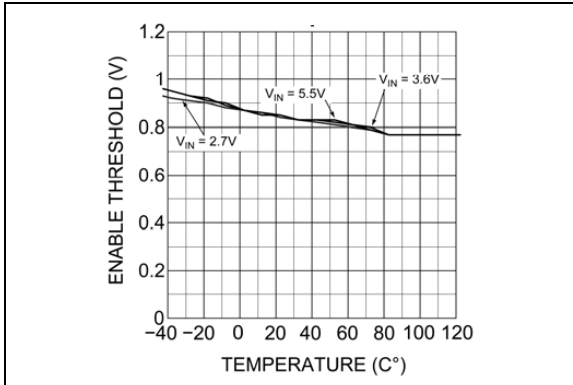
**FIGURE 2-11:** Switching Frequency vs. Output Current.



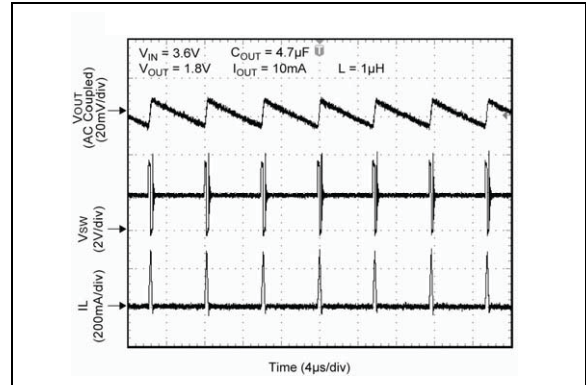
**FIGURE 2-9:** Frequency vs. Temperature.



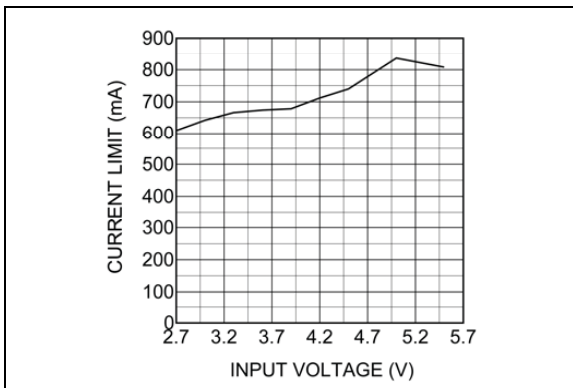
**FIGURE 2-12:** Enable Threshold vs. Input Voltage.



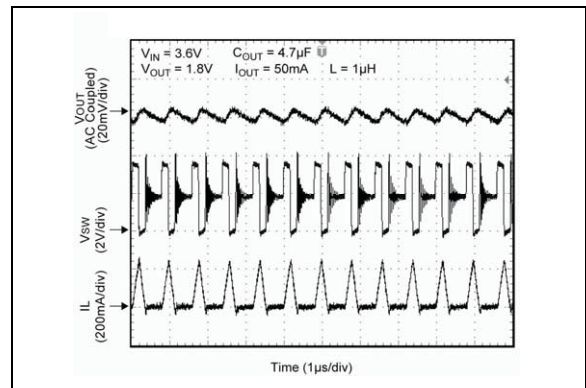
**FIGURE 2-13:** Enable Threshold vs. Temperature.



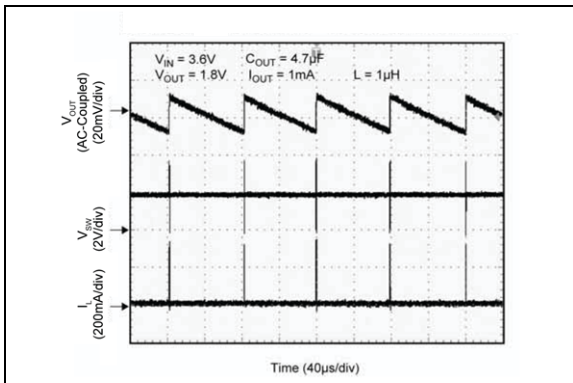
**FIGURE 2-16:** Switching Waveform - Discontinuous Mode.



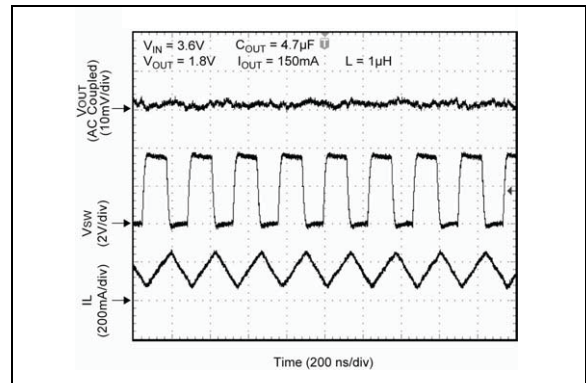
**FIGURE 2-14:** Current-Limit vs. Input Voltage.



**FIGURE 2-17:** Switching Waveform - Discontinuous Mode.

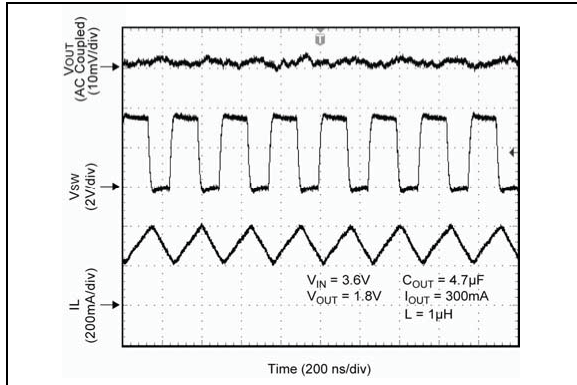


**FIGURE 2-15:** Switching Waveform - Discontinuous Mode.

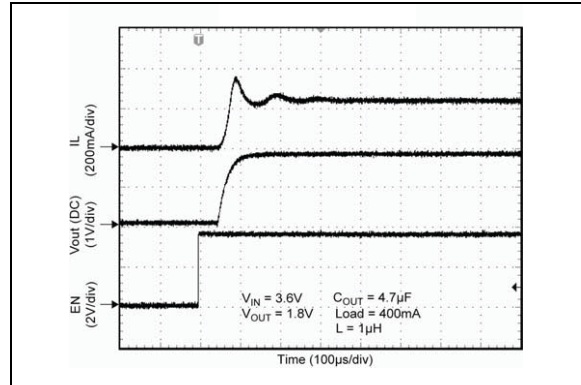


**FIGURE 2-18:** Switching Waveform - Continuous Mode.

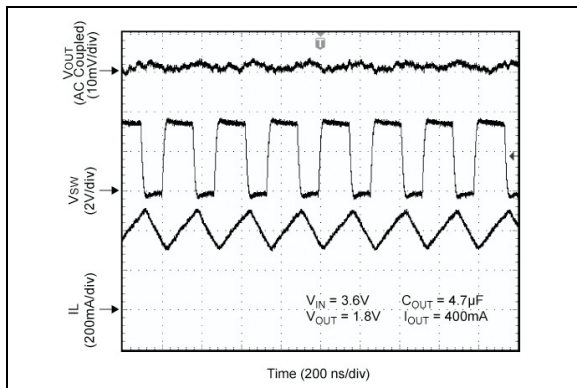
# MIC23031



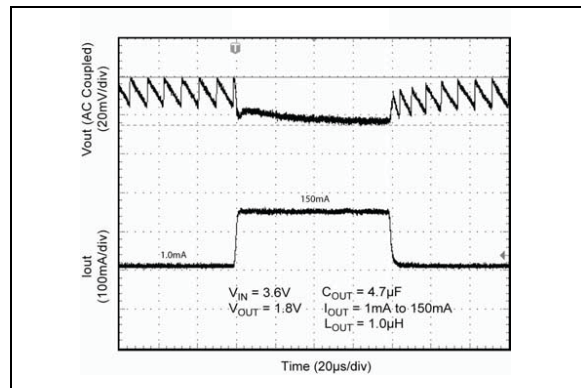
**FIGURE 2-19:** Switching Waveform - Continuous Mode.



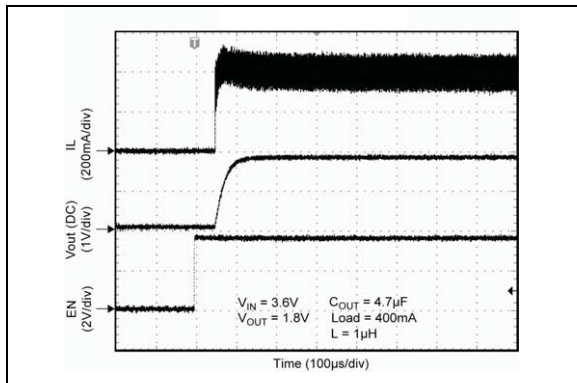
**FIGURE 2-22:** Start-Up Waveform.



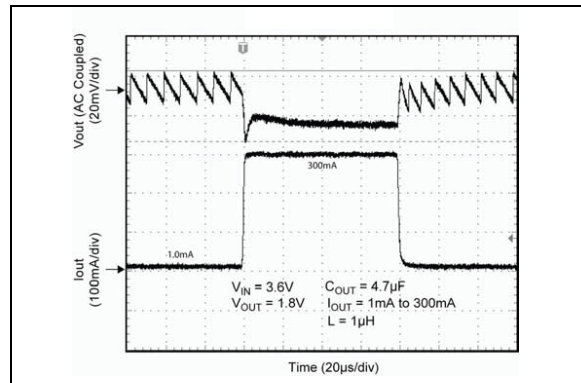
**FIGURE 2-20:** Switching Waveform - Continuous Mode.



**FIGURE 2-23:** Load Transient.

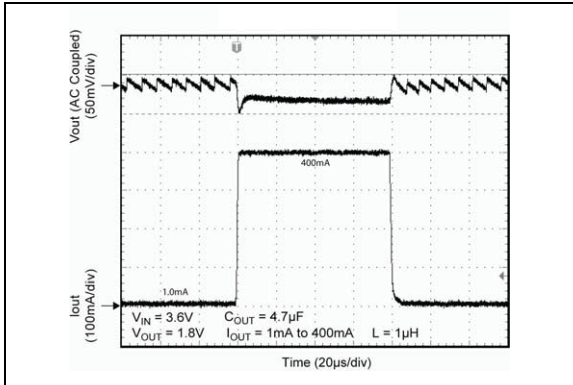


**FIGURE 2-21:** Start-Up Waveform.

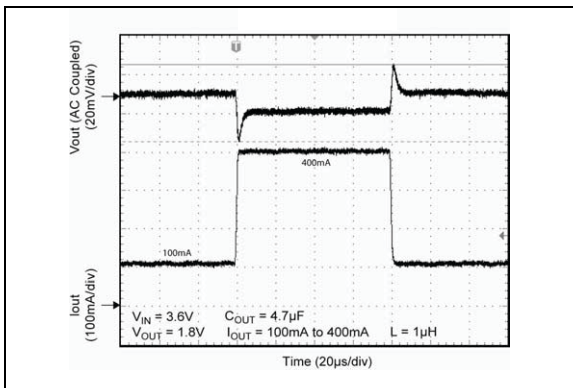


**FIGURE 2-24:** Load Transient.

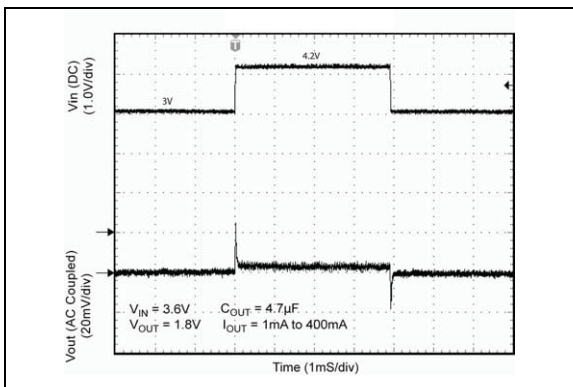




**FIGURE 2-25:** Load Transient.



**FIGURE 2-26:** Load Transient.



**FIGURE 2-27:** Line Transient.

# MIC23031

## 3.0 PIN DESCRIPTIONS

The descriptions of the pins are listed in [Table 3-1](#).

**TABLE 3-1: PIN FUNCTION TABLE**

Pin Number (Fixed)	Pin Number (Adjustable)	Pin Name	Description
1	1	VIN	Input Voltage: Connect a capacitor to ground to decouple the noise.
2	2	SW	Switch (Output): Internal power MOSFET output switches.
3	3	SNS	Sense: Connect to $V_{OUT}$ as close to output capacitor as possible to sense output voltage.
4	4	EN	Enable (Input): Logic-high enables operation of the regulator. Logic-low will shut down the device. Do not leave floating.
5	—	AGND	Analog Ground: Connect to central ground point where all high-current paths meet ( $C_{IN}$ , $C_{OUT}$ , $P_{GND}$ ) for best operation.
—	5	FB	Feedback (Input): Connect resistor divider at this node to set output voltage. Resistors should be selected based on a nominal $V_{FB}$ of 0.62V.
6	—	PGND	Power Ground.
—	6	GND	Ground.
ePAD	ePAD	HS PAD	Connect to PGND or AGND.

## 4.0 FUNCTIONAL DESCRIPTION

### 4.1 VIN

The input supply ( $V_{IN}$ ) provides power to the internal MOSFETs for the switch mode regulator along with the internal control circuitry. The  $V_{IN}$  operating range is 2.7V to 5.5V, so an input capacitor with a minimum voltage rating of 6.3V is recommended. Due to the high switching speed, a minimum 2.2  $\mu\text{F}$  bypass capacitor placed close to  $V_{IN}$  and the power ground (PGND) pin is required.

### 4.2 EN

A logic high signal on the enable pin activates the output voltage of the device. A logic low signal on the enable pin deactivates the output and reduces supply current to 0.01  $\mu\text{A}$ . The MIC23031 features built-in soft-start circuitry that reduces in-rush current and prevents the output voltage from overshooting at start up. Do not leave the enable pin floating.

### 4.3 SW

The switch (SW) connects directly to one end of the inductor and provides the current path during switching cycles. The other end of the inductor is connected to the load, SNS pin and output capacitor. Because of the high speed switching on this pin, the switch node should be routed away from sensitive nodes whenever possible.

### 4.4 SNS

The sense (SNS) pin is connected to the output of the device to provide feedback to the control circuitry. The SNS connection should be placed close to the output capacitor.

### 4.5 AGND (Fixed Output Only)

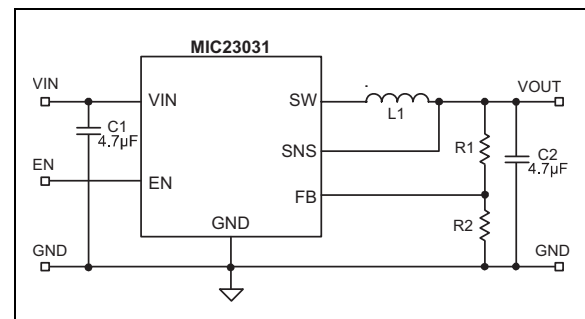
The analog ground (AGND) is the ground path for the biasing and control circuitry. The current loop for the signal ground should be separate from the power ground (PGND) loop.

### 4.6 FB (Adjustable Output Only)

The feedback pin (FB) allows the regulated output voltage to be set by applying an external resistor network. The internal reference voltage is 0.62V and the recommended value of R2 is 200 k $\Omega$ . The output voltage is calculated using Equation 4-1.

#### EQUATION 4-1:

$$V_{OUT} = 0.62V \left( \frac{R1}{200k\Omega} + 1 \right)$$



**FIGURE 4-1:** MIC23031-AYMT Schematic.

### 4.7 PGND/GND

The power ground pin is the ground path for the high current in PWM mode. The current loop for the power ground should be as small as possible and separate from the analog ground (AGND) loop as applicable.

# MIC23031

## 5.0 APPLICATION INFORMATION

The MIC23031 is a high-performance DC/DC step-down regulator that offers a small solution size. Supporting an output current up to 400 mA inside a tiny 1.6 mm x 1.6 mm TDFN package and requiring only three external components, the MIC23031 meets today's miniature portable electronic device needs. Using the HyperLight Load<sup>®</sup> switching scheme, the MIC23031 is able to maintain high efficiency throughout the entire load range while providing ultra-fast load transient response. The following sections provide additional device application information.

### 5.1 Input Capacitor

A 2.2  $\mu\text{F}$  ceramic capacitor or greater should be placed close to the VIN pin and PGND pin for bypassing. A TDK C1608X7S0J475K080AC, size 0603, 4.7  $\mu\text{F}$  ceramic capacitor is recommended based upon performance, size, and cost. A X5R or X7R temperature rating is recommended for the input capacitor. Y5V temperature rating capacitors, aside from losing most of their capacitance over temperature, can also become resistive at high frequencies. This reduces their ability to filter out high frequency noise.

### 5.2 Output Capacitor

The MIC23031 is designed for use with a 2.2  $\mu\text{F}$  or greater ceramic output capacitor. Increasing the output capacitance will lower output ripple and improve load transient response but could increase solution size or cost. A low equivalent series resistance (ESR) ceramic output capacitor such as the TDK C1608X5R0J475K, size 0603, 4.7  $\mu\text{F}$  ceramic capacitor is recommended based upon performance, size and cost. Both the X7R or X5R temperature rating capacitors are recommended. The Y5V and Z5U temperature rating capacitors are not recommended due to their wide variation in capacitance over temperature and increased resistance at high frequencies.

### 5.3 Inductor Selection

When selecting an inductor, it is important to consider the following factors (not necessarily in the order of importance):

- Inductance
- Rated Current Value
- Size Requirements
- DC Resistance (DCR)

The MIC23031 was designed for use with an inductance range from 0.47  $\mu\text{H}$  to 4.7  $\mu\text{H}$ . Typically, a 1  $\mu\text{H}$  inductor is recommended for a balance of transient response, efficiency, and output ripple. For faster transient response, a 0.47  $\mu\text{H}$  inductor will yield the best result. For lower output ripple, a 4.7  $\mu\text{H}$  inductor is recommended.

Maximum current ratings of the inductor are generally given in two methods; permissible DC current and saturation current. Permissible DC current can be rated either for a 40°C temperature rise or a 10% to 20% loss in inductance. Ensure the inductor selected can handle the maximum operating current. When saturation current is specified, make sure that there is enough margin so that the peak current does not cause the inductor to saturate. Peak current can be calculated as follows:

#### EQUATION 5-1:

$$I_{PEAK} = \left[ I_{OUT} + V_{OUT} \left( \frac{1 - V_{OUT}/V_{IN}}{2 \times f \times L} \right) \right]$$

As shown by the calculation above, the peak inductor current is inversely proportional to the switching frequency and the inductance; the lower the switching frequency or the inductance, the higher the peak current. As input voltage increases, the peak current also increases.

The size of the inductor depends on the requirements of the application. DC resistance (DCR) is also important. While DCR is inversely proportional to size, DCR can represent a significant efficiency loss. Refer to the [Efficiency Considerations](#) section.

### 5.4 Compensation

The MIC23031 is designed to be stable with a 0.47  $\mu\text{H}$  to 4.7  $\mu\text{H}$  inductor with a minimum of 2.2  $\mu\text{F}$  ceramic (X5R) output capacitor.

### 5.5 Duty Cycle

The typical maximum duty cycle of the MIC23031 is 80%.

### 5.6 Efficiency Considerations

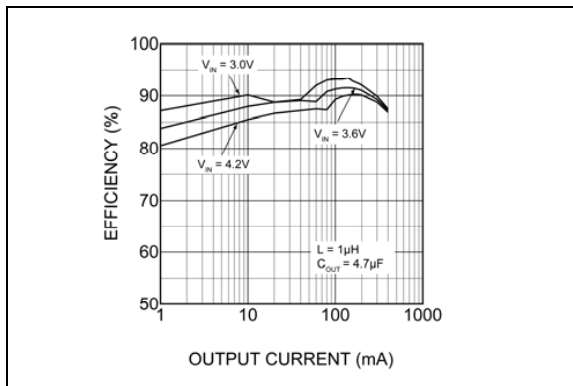
Efficiency is defined as the amount of useful output power, divided by the amount of power supplied.

## EQUATION 5-2:

$$\eta = \left( \frac{V_{OUT} \times I_{OUT}}{V_{IN} \times I_{IN}} \right) \times 100$$

Maintaining high efficiency serves two purposes. It reduces power dissipation in the power supply, reducing the need for heat sinks and thermal design considerations and it reduces consumption of current for battery powered applications. Reduced current draw from a battery increases the devices operating time which is critical in hand held devices.

There are two types of losses in switching converters; DC losses and switching losses. DC losses are simply the power dissipation of  $I^2R$ . Power is dissipated in the high-side switch during the on cycle. Power loss is equal to the high-side MOSFET  $R_{DS(ON)}$  multiplied by the switch current squared. During the off cycle, the low-side N-channel MOSFET conducts, also dissipating power. Device operating current also reduces efficiency. The product of the quiescent (operating) current and the supply voltage represents another DC loss. The current required driving the gates on and off at a constant 4 MHz frequency and the switching transitions make up the switching losses.



**FIGURE 5-1:** Efficiency under Load.

Figure 5-1 shows an efficiency curve. From no load to 100 mA, efficiency losses are dominated by quiescent current losses, gate drive and transition losses. By using the HyperLight Load mode, the MIC23031 is able to maintain high efficiency at low output currents.

Over 100 mA, efficiency loss is dominated by MOSFET  $R_{DS(ON)}$  and inductor losses. Higher input supply voltages will increase the gate to source threshold on the internal MOSFETs, thereby reducing the internal  $R_{DS(ON)}$ . This improves efficiency by reducing DC losses in the device. All but the inductor losses are inherent to the device. In which case, inductor selection becomes increasingly critical in efficiency calculations. As the inductors are reduced in size, the DC resistance (DCR) can become quite significant.

The DCR losses can be calculated by using Equation 5-3:

## EQUATION 5-3:

$$LPd = I_{OUT}^2 \times DCR$$

From that, the loss in efficiency due to inductor resistance can be calculated by using Equation 5-4:

## EQUATION 5-4:

$$EfficiencyLoss = \left[ 1 - \left( \frac{V_{OUT} \times I_{OUT}}{V_{OUT} \times I_{OUT} + P_{DCR}} \right) \right] \times 100$$

Efficiency loss due to DCR is minimal at light loads and gains significance as the load is increased. Inductor selection becomes a trade-off between efficiency and size in this case.

## 5.7 HyperLight Load® Mode

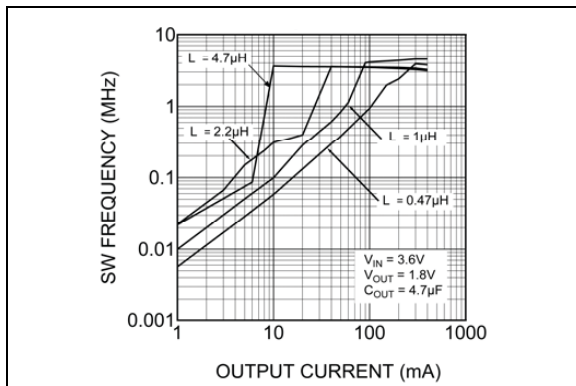
MIC23031 uses a minimum on-time and off-time proprietary control loop. When the output voltage falls below the regulation threshold, the error comparator begins a switching cycle that turns the PMOS on and keeps it on for the duration of the minimum on-time. This increases the output voltage. If the output voltage is over the regulation threshold, then the error comparator turns the PMOS off for a minimum off-time until the output drops below the threshold. The NMOS acts as an ideal rectifier that conducts when the PMOS is off. Using a NMOS switch instead of a diode allows for lower voltage drop across the switching device when it is on. The asynchronous switching combination between the PMOS and the NMOS allows the control loop to work in discontinuous mode for light load operations. In discontinuous mode, the MIC23031 works in pulse frequency modulation (PFM) to regulate the output. As the output current increases, the off-time decreases, thus provides more energy to the output. This switching scheme improves the efficiency of MIC23031 during light load currents by only switching when it is needed. As the load current increases, the MIC23031 goes into continuous conduction mode (CCM) and switches at a frequency centered at 4 MHz. The equation to calculate the load when the MIC23031 goes into continuous conduction mode may be approximated by the following Equation 5-5:

# MIC23031

## EQUATION 5-5:

$$I_{LOAD} > \frac{(V_{IN} - V_{OUT}) \times D}{2L \times f}$$

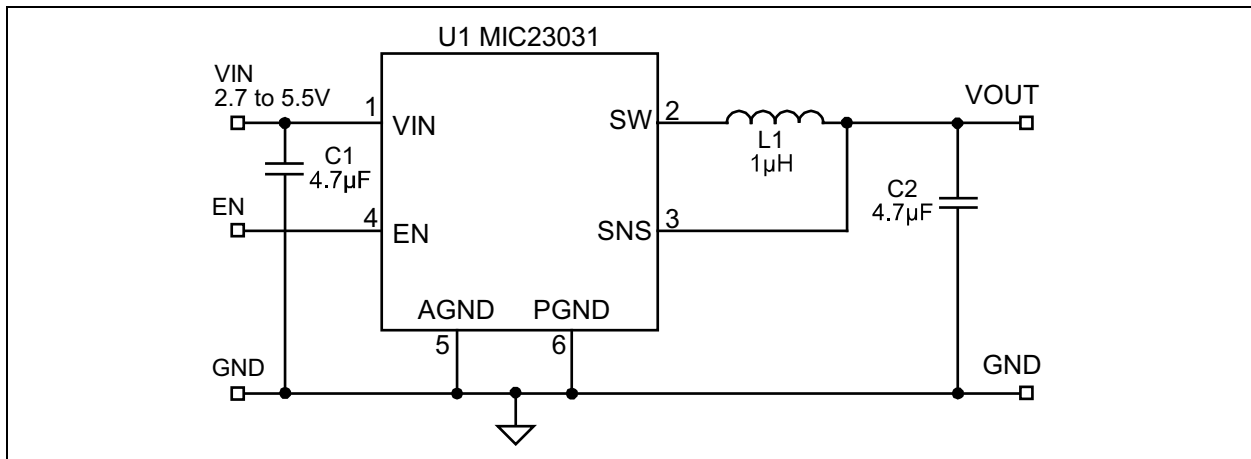
As shown in Equation 5-5, the load at which MIC23031 transitions from HyperLight Load mode to PWM mode is a function of the input voltage ( $V_{IN}$ ), output voltage ( $V_{OUT}$ ), duty cycle ( $D$ ), inductance ( $L$ ), and frequency ( $f$ ). Because the inductance range of MIC23031 is from  $0.47 \mu\text{H}$  to  $4.7 \mu\text{H}$ , the device may then be tailored to enter HyperLight Load mode or PWM mode at a specific load current by selecting the appropriate inductance. For example, in the graph below, when the inductance is  $4.7 \mu\text{H}$  the MIC23031 will transition into PWM mode at a load of approximately 4 mA. Under the same condition, when the inductance is  $1 \mu\text{H}$ , the MIC23031 will transition into PWM mode at approximately 70 mA.



**FIGURE 5-2:** Switching Frequency vs. Inductance.

## 6.0 MIC23031 TYPICAL APPLICATION CIRCUITS

### 6.1 Fixed 1.8V



### Bill of Materials

**TABLE 6-1: FIXED 1.8V BILL OF MATERIALS**

Item	Part Number	Manufacturer	Description	Qty.
C1, C2	C1608X5R0J475K	TDK <sup>(1)</sup>	4.7µF Ceramic Capacitor, 6.3V, X5R, Size 0603	2
L1	LQM21PN1R0M00	Murata <sup>(2)</sup>	1µH, 0.8A, 190mΩ, L2mm x W1.25mm x H0.5mm	1
	LQH32CN1R0M33	Murata <sup>(2)</sup>	1µH, 1A, 60mΩ, L3.2mm x W2.5mm x H2.0mm	
	LQM31PN1R0M00	Murata <sup>(2)</sup>	1µH, 1.2A, 120mΩ, L3.2mm x W1.6mm x H0.95mm	
	GLF251812T1R0M	TDK <sup>(1)</sup>	1µH, 0.8A, 100mΩ, L2.5mm x W1.8mm x H1.35mm	
	LQM31PNR47M00	Murata <sup>(2)</sup>	0.47µH, 1.4A, 80mΩ, L3.2mm x W1.6mm x H0.85mm	
	MIPF2520D1R5	FDK <sup>(3)</sup>	1.5µH, 1.5A, 70mΩ, L2.5mm x W2mm x H1.0mm	
U1	MIC23031-xYMT	Microchip <sup>(4)</sup>	4 MHz 400 mA Buck Regulator with HyperLight Load <sup>®</sup> Mode	1

**Note 1:** TDK: [www.tdk.com](http://www.tdk.com)

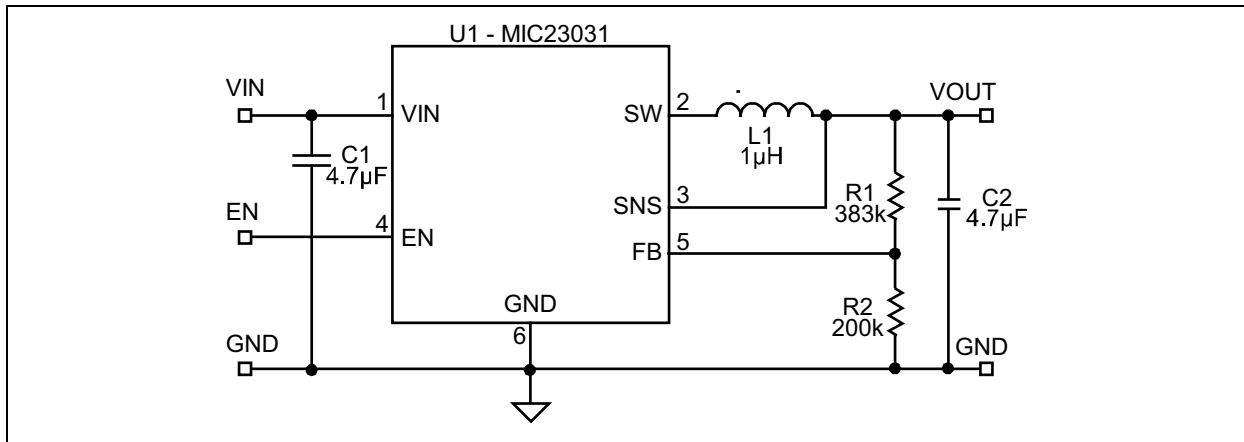
**2:** Murata: [www.murata.com](http://www.murata.com)

**3:** FDK: [www.fdk.jp.co](http://www.fdk.jp.co)

**4:** Microchip Technology Inc: [www.microchip.com](http://www.microchip.com)

# MIC23031

## 6.2 Adjustable 1.8V



### Bill of Materials

TABLE 6-2: ADJUSTABLE 1.8V BILL OF MATERIALS

Item	Part Number	Manufacturer	Description	Qty.
C1, C2	C1608X5R0J475K	TDK <sup>(1)</sup>	4.7µF Ceramic Capacitor, 6.3V, X5R, Size 0603	2
R1	CRCW06033833FT1	Vishay <sup>(2)</sup>	383kΩ, 1%, Size 0603	1
R2	CRCW06032003FT1	Vishay <sup>(2)</sup>	200kΩ, 1%, Size 0603	1
L1	LQM21PN1R0M00	Murata <sup>(3)</sup>	1µH, 0.8A, 190mΩ, L2mm x W1.25mm x H0.5mm	1
	LQH32CN1R0M33	Murata <sup>(3)</sup>	1µH, 1A, 60mΩ, L3.2mm x W2.5mm x H2.0mm	
	LQM31PN1R0M00	Murata <sup>(3)</sup>	1µH, 1.2A, 120mΩ, L3.2mm x W1.6mm x H0.95mm	
	GLF251812T1R0M	TDK <sup>(1)</sup>	1µH, 0.8A, 100mΩ, L2.5mm x W1.8mm x H1.35mm	
	LQM31PNR47M00	Murata <sup>(3)</sup>	0.47µH, 1.4A, 80mΩ, L3.2mm x W1.6mm x H0.85mm	
	MIPF2520D1R5	FDK <sup>(4)</sup>	1.5µH, 1.5A, 70mΩ, L2.5mm x W2mm x H1.0mm	
U1	MIC23031-xYMT	Microchip <sup>(5)</sup>	<b>4 MHz 400 mA Buck Regulator with HyperLight Load<sup>®</sup> Mode</b>	1

Note 1: TDK: [www.tdk.com](http://www.tdk.com)

Note 2: Vishay: [www.vishay.com](http://www.vishay.com)

Note 3: Murata: [www.murata.com](http://www.murata.com)

Note 4: FDK: [www.fdk.jp.co](http://www.fdk.jp.co)

Note 5: Microchip Technology Inc: [www.microchip.com](http://www.microchip.com)



## 7.0 PCB LAYOUT RECOMMENDATIONS

### 7.1 Fixed

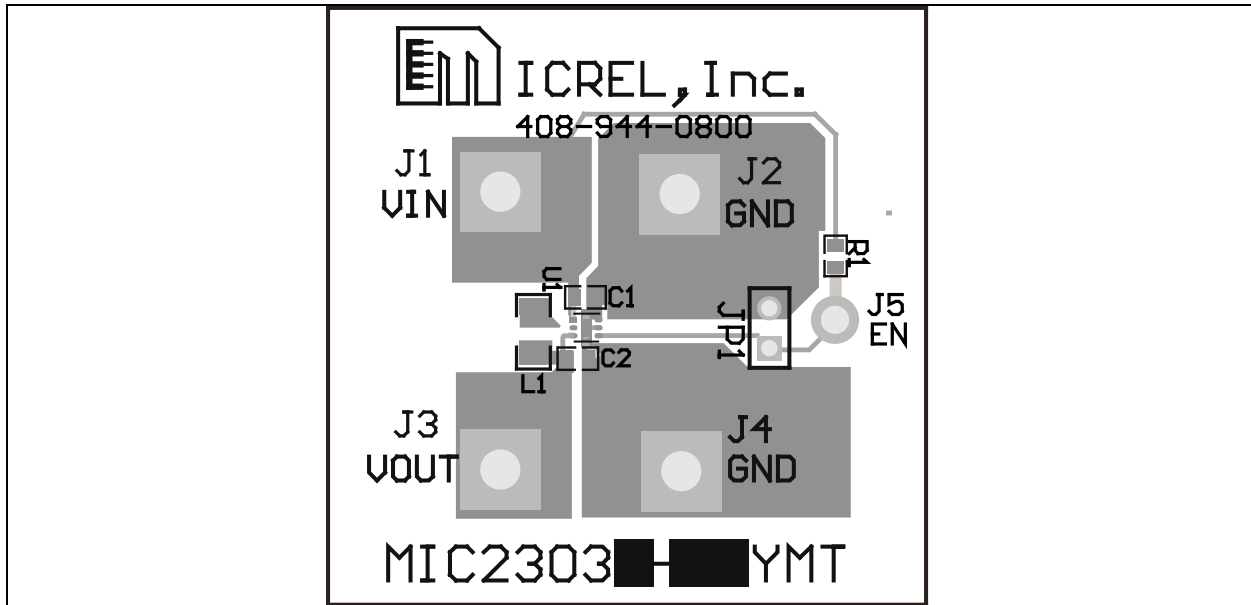


FIGURE 7-1: Fixed Top Layer.

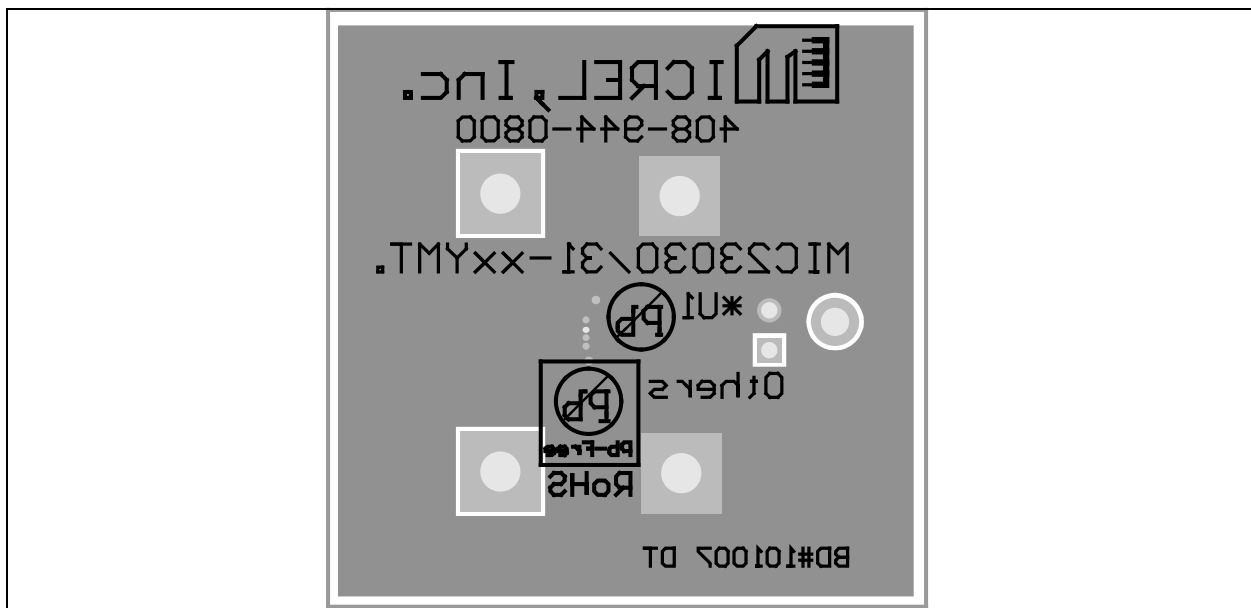


FIGURE 7-2: Fixed Bottom Layer.

# MIC23031

## 7.2 Adjustable

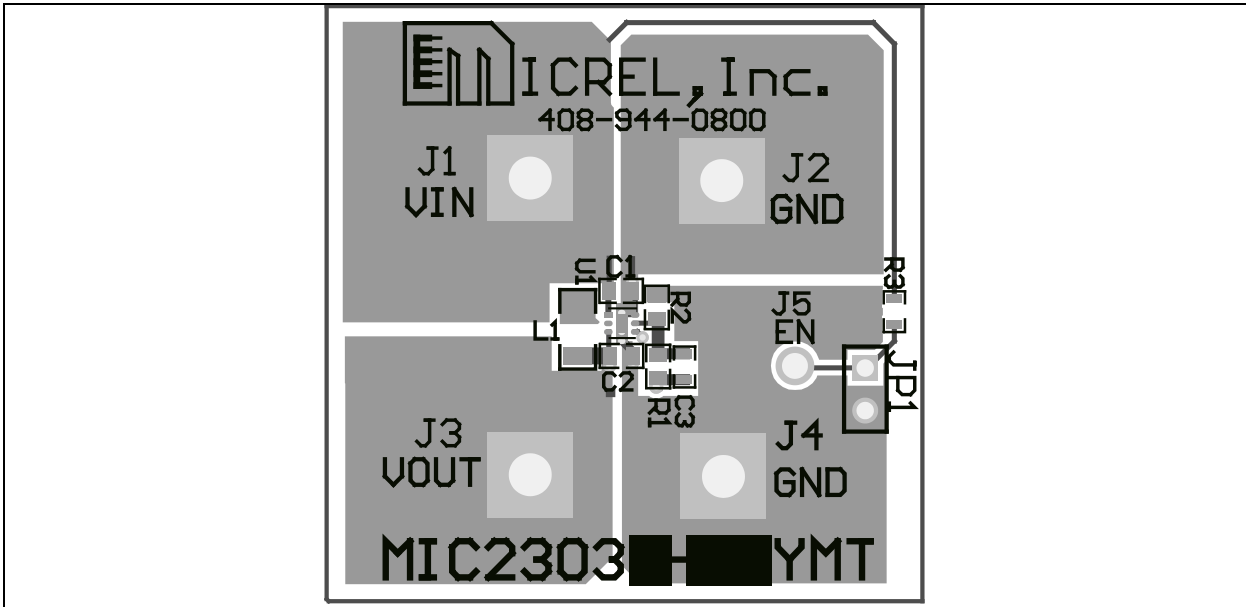


FIGURE 7-3: Adjustable Top Layer.

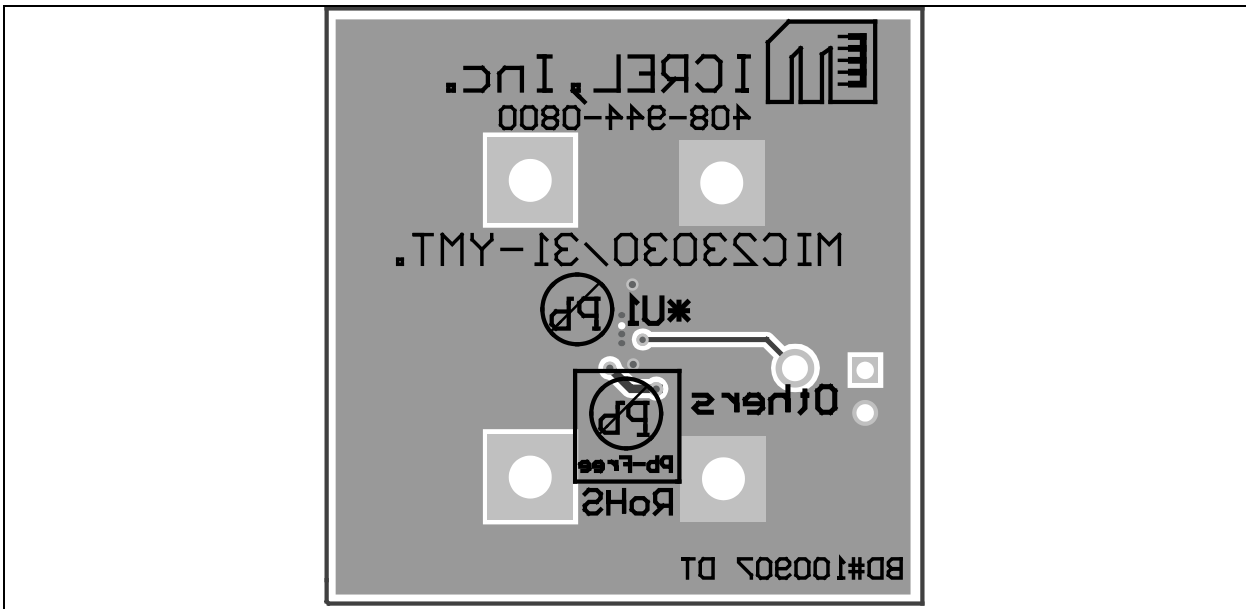
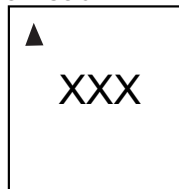


FIGURE 7-4: Adjustable Bottom Layer.

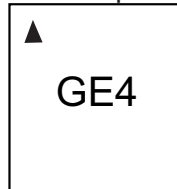
## 8.0 PACKAGING INFORMATION

### 8.1 Package Marking Information

6-Lead TDFN\*



Example



**TABLE 8-1: MIC23031 PACKAGE MARKING CODES**

Part Number	Output Voltage	Marking Code
MIC23031-AYMT	Adjustable	GEA
MIC23031-GYMT	1.8V	GEG
MIC23031-FYMY	1.5V	GEF
MIC23031-4YMT	1.2V	GE4
MIC23031-CYMT	1.0V	GEC

<p><b>Legend:</b></p> <ul style="list-style-type: none"> <li>XX...X Product code or customer-specific information</li> <li>Y Year code (last digit of calendar year)</li> <li>YY Year code (last 2 digits of calendar year)</li> <li>WW Week code (week of January 1 is week '01')</li> <li>NNN Alphanumeric traceability code</li> <li>(e3) Pb-free JEDEC® designator for Matte Tin (Sn)</li> <li>* This package is Pb-free. The Pb-free JEDEC designator ((e3)) can be found on the outer packaging for this package.</li> <li>•, ▲, ▼ Pin one index is identified by a dot, delta up, or delta down (triangle mark).</li> </ul>
<p><b>Note:</b> In the event the full Microchip part number cannot be marked on one line, it will be carried over to the next line, thus limiting the number of available characters for customer-specific information. Package may or may not include the corporate logo.</p> <p>Underbar ( _ ) and/or Overbar ( ¯ ) symbol may not be to scale.</p>

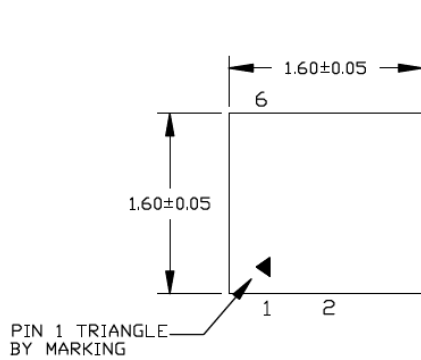
# MIC23031

## 6-Lead TDFN 1.6 mm x 1.6 mm Package Outline and Recommended Land Pattern

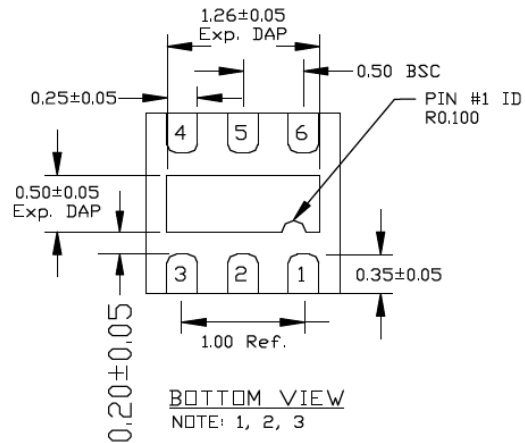
**TITLE**

6 LEAD TDFN 1.6x1.6mm PACKAGE OUTLINE & RECOMMENDED LAND PATTERN

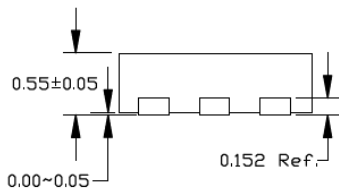
DRAWING #	TDFN1616-6LD-PL-1	UNIT	MM
-----------	-------------------	------	----



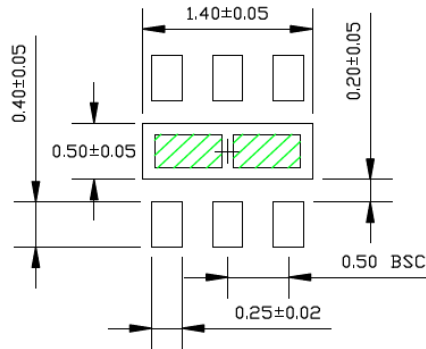
TOP VIEW  
NOTE: 1, 2, 3



BOTTOM VIEW  
NOTE: 1, 2, 3



SIDE VIEW  
NOTE: 1, 2, 3



RECOMMENDED LAND PATTERN

**NOTE:**

1. MAX PACKAGE WARPAGE IS 0.05 MM
2. MAX ALLOWABLE BURR IS 0.076MM IN ALL DIRECTIONS
3. PIN #1 IS ON TOP WILL BE LASER MARKED
4. GREEN SHADED AREA REPRESENT SOLDER STENCIL OPENING (OPTIONAL) FOR IMPROVED THERMAL PERFORMANCE. SIZE: 0.55x0.30MM

Note: For the most current package drawings, please see the Microchip Packaging Specification located at <http://www.microchip.com/packaging>.

## APPENDIX A: REVISION HISTORY

### Revision A (May 2021)

- Converted Micrel document MIC23031 to Microchip data sheet DS20006538A.
- Minor text changes throughout.

# MIC23031

---

NOTES:

## PRODUCT IDENTIFICATION SYSTEM

To order or obtain information, e.g., on pricing or delivery, contact your local Microchip representative or sales office.

<u>PART NO.</u>	<u>-X</u>	<u>X</u>	<u>XX</u>	<u>-XX</u>	<b>Examples:</b>
<b>Device</b>	<b>Output Voltage</b>	<b>Junction Temperature Range</b>	<b>Package Option</b>	<b>Media Type</b>	
<b>Device:</b>	MIC23031: 4 MHz PWM 400 mA Buck Regulator with HyperLight Load®				a) MIC23031-AYMT-TR: 4 MHz PWM 400 mA Buck Regulator with HyperLight Load®, Adjustable Output Voltage, -40°C to +125°C Junction Temperature Range, 6-Lead TDFN Package, 5000/Reel
<b>Output Voltage:</b>	A = Adjustable G = 1.8V F = 1.5V 4 = 1.2V C = 1.0V				b) MIC23031-GYMT-TR: 4 MHz PWM 400 mA Buck Regulator with HyperLight Load®, 1.8V Fixed Output Voltage, -40°C to +125°C Junction Temperature Range, 6-Lead TDFN Package, 5000/Reel
<b>Junction Temperature Range:</b>	Y = -40°C to +125°C				c) MIC23031-FYMT-TR: 4 MHz PWM 400 mA Buck Regulator with HyperLight Load®, 1.5V Fixed Output Voltage, -40°C to +125°C Junction Temperature Range, 6-Lead TDFN Package, 5000/Reel
<b>Package:</b>	MT = 6-Lead 1.6 mm x 1.6 mm TDFN				d) MIC23031-4YMT-TR: 4 MHz PWM 400 mA Buck Regulator with HyperLight Load®, 1.2V Fixed Output Voltage, -40°C to +125°C Junction Temperature Range, 6-Lead TDFN Package, 5000/Reel
<b>Media Type:</b>	TR = 5000/Reel				e) MIC23031-CYMT-TR: 4 MHz PWM 400 mA Buck Regulator with HyperLight Load®, 1.0V Fixed Output Voltage, -40°C to +125°C Junction Temperature Range, 6-Lead TDFN Package, 5000/Reel
<b>Note:</b> Other voltages available. Contact Factory for details.					<b>Note 1:</b> Tape and Reel identifier only appears in the catalog part number description. This identifier is used for ordering purposes and is not printed on the device package. Check with your Microchip Sales Office for package availability with the Tape and Reel option.

# MIC23031

---

NOTES:



---

**Note the following details of the code protection feature on Microchip devices:**

- Microchip products meet the specifications contained in their particular Microchip Data Sheet.
- Microchip believes that its family of products is secure when used in the intended manner and under normal conditions.
- There are dishonest and possibly illegal methods being used in attempts to breach the code protection features of the Microchip devices. We believe that these methods require using the Microchip products in a manner outside the operating specifications contained in Microchip's Data Sheets. Attempts to breach these code protection features, most likely, cannot be accomplished without violating Microchip's intellectual property rights.
- Microchip is willing to work with any customer who is concerned about the integrity of its code.
- Neither Microchip nor any other semiconductor manufacturer can guarantee the security of its code. Code protection does not mean that we are guaranteeing the product is "unbreakable." Code protection is constantly evolving. We at Microchip are committed to continuously improving the code protection features of our products. Attempts to break Microchip's code protection feature may be a violation of the Digital Millennium Copyright Act. If such acts allow unauthorized access to your software or other copyrighted work, you may have a right to sue for relief under that Act.

---

Information contained in this publication is provided for the sole purpose of designing with and using Microchip products. Information regarding device applications and the like is provided only for your convenience and may be superseded by updates. It is your responsibility to ensure that your application meets with your specifications.

THIS INFORMATION IS PROVIDED BY MICROCHIP "AS IS". MICROCHIP MAKES NO REPRESENTATIONS OR WARRANTIES OF ANY KIND WHETHER EXPRESS OR IMPLIED, WRITTEN OR ORAL, STATUTORY OR OTHERWISE, RELATED TO THE INFORMATION INCLUDING BUT NOT LIMITED TO ANY IMPLIED WARRANTIES OF NON-INFRINGEMENT, MERCHANTABILITY, AND FITNESS FOR A PARTICULAR PURPOSE OR WARRANTIES RELATED TO ITS CONDITION, QUALITY, OR PERFORMANCE.

IN NO EVENT WILL MICROCHIP BE LIABLE FOR ANY INDIRECT, SPECIAL, PUNITIVE, INCIDENTAL OR CONSEQUENTIAL LOSS, DAMAGE, COST OR EXPENSE OF ANY KIND WHATSOEVER RELATED TO THE INFORMATION OR ITS USE, HOWEVER CAUSED, EVEN IF MICROCHIP HAS BEEN ADVISED OF THE POSSIBILITY OR THE DAMAGES ARE FORESEEABLE. TO THE FULLEST EXTENT ALLOWED BY LAW, MICROCHIP'S TOTAL LIABILITY ON ALL CLAIMS IN ANY WAY RELATED TO THE INFORMATION OR ITS USE WILL NOT EXCEED THE AMOUNT OF FEES, IF ANY, THAT YOU HAVE PAID DIRECTLY TO MICROCHIP FOR THE INFORMATION. Use of Microchip devices in life support and/or safety applications is entirely at the buyer's risk, and the buyer agrees to defend, indemnify and hold harmless Microchip from any and all damages, claims, suits, or expenses resulting from such use. No licenses are conveyed, implicitly or otherwise, under any Microchip intellectual property rights unless otherwise stated.

**Trademarks**

The Microchip name and logo, the Microchip logo, Adaptec, AnyRate, AVR, AVR logo, AVR Freaks, BesTime, BitCloud, chipKIT, chipKIT logo, CryptoMemory, CryptoRF, dsPIC, FlashFlex, flexPWR, HELDO, IGL00, JukeBlox, KeeLoq, Kleer, LANCheck, LinkMD, maXStylus, maXTouch, MediaLB, megaAVR, Microsemi, Microsemi logo, MOST, MOST logo, MPLAB, OptoLyzer, PackeTime, PIC, picoPower, PICSTART, PIC32 logo, PolarFire, Prochip Designer, QTouch, SAM-BA, SenGenuity, SpyNIC, SST, SST Logo, SuperFlash, Symmetricom, SyncServer, Tachyon, TimeSource, tinyAVR, UNI/O, Vectron, and XMEGA are registered trademarks of Microchip Technology Incorporated in the U.S.A. and other countries.

AgileSwitch, APT, ClockWorks, The Embedded Control Solutions Company, EtherSynch, FlashTec, Hyper Speed Control, HyperLight Load, IntelliMOS, Libero, motorBench, mTouch, Powermite 3, Precision Edge, ProASIC, ProASIC Plus, ProASIC Plus logo, Quiet-Wire, SmartFusion, SyncWorld, Temux, TimeCesium, TimeHub, TimePictra, TimeProvider, WinPath, and ZL are registered trademarks of Microchip Technology Incorporated in the U.S.A.

Adjacent Key Suppression, AKS, Analog-for-the-Digital Age, Any Capacitor, AnyIn, AnyOut, Augmented Switching, BlueSky, BodyCom, CodeGuard, CryptoAuthentication, CryptoAutomotive, CryptoCompanion, CryptoController, dsPICDEM, dsPICDEM.net, Dynamic Average Matching, DAM, ECAN, Espresso T1S, EtherGREEN, IdealBridge, In-Circuit Serial Programming, ICSP, INICnet, Intelligent Paralleling, Inter-Chip Connectivity, JitterBlocker, maxCrypto, maxView, memBrain, Mindi, MiWi, MPASM, MPF, MPLAB Certified logo, MPLIB, MPLINK, MultiTRAK, NetDetach, Omniscient Code Generation, PICDEM, PICDEM.net, PICkit, PICtail, PowerSmart, PureSilicon, QMatrix, REAL ICE, Ripple Blocker, RTAX, RTG4, SAM-ICE, Serial Quad I/O, simpleMAP, SimpliPHY, SmartBuffer, SMART-I.S., storClad, SQI, SuperSwitcher, SuperSwitcher II, Switchtec, SynchroPHY, Total Endurance, TSHARC, USBCheck, VariSense, VectorBlox, VeriPHY, ViewSpan, WiperLock, XpressConnect, and ZENA are trademarks of Microchip Technology Incorporated in the U.S.A. and other countries.

SQTP is a service mark of Microchip Technology Incorporated in the U.S.A.

The Adaptec logo, Frequency on Demand, Silicon Storage Technology, and Symmcom are registered trademarks of Microchip Technology Inc. in other countries.

GestIC is a registered trademark of Microchip Technology Germany II GmbH & Co. KG, a subsidiary of Microchip Technology Inc., in other countries.

All other trademarks mentioned herein are property of their respective companies.

© 2021, Microchip Technology Incorporated, All Rights Reserved.

ISBN: 978-1-5224-8229-1

For information regarding Microchip's Quality Management Systems, please visit [www.microchip.com/quality](http://www.microchip.com/quality).



# MICROCHIP

## Worldwide Sales and Service

### AMERICAS

**Corporate Office**  
2355 West Chandler Blvd.  
Chandler, AZ 85224-6199  
Tel: 480-792-7200  
Fax: 480-792-7277  
Technical Support:  
<http://www.microchip.com/support>  
Web Address:  
[www.microchip.com](http://www.microchip.com)

#### Atlanta

Duluth, GA  
Tel: 678-957-9614  
Fax: 678-957-1455

#### Austin, TX

Tel: 512-257-3370

#### Boston

Westborough, MA  
Tel: 774-760-0087  
Fax: 774-760-0088

#### Chicago

Itasca, IL  
Tel: 630-285-0071  
Fax: 630-285-0075

#### Dallas

Addison, TX  
Tel: 972-818-7423  
Fax: 972-818-2924

#### Detroit

Novi, MI  
Tel: 248-848-4000

#### Houston, TX

Tel: 281-894-5983

#### Indianapolis

Noblesville, IN  
Tel: 317-773-8323  
Fax: 317-773-5453  
Tel: 317-536-2380

#### Los Angeles

Mission Viejo, CA  
Tel: 949-462-9523  
Fax: 949-462-9608  
Tel: 951-273-7800

#### Raleigh, NC

Tel: 919-844-7510

#### New York, NY

Tel: 631-435-6000

#### San Jose, CA

Tel: 408-735-9110  
Tel: 408-436-4270

#### Canada - Toronto

Tel: 905-695-1980  
Fax: 905-695-2078

### ASIA/PACIFIC

**Australia - Sydney**  
Tel: 61-2-9868-6733

**China - Beijing**  
Tel: 86-10-8569-7000

**China - Chengdu**  
Tel: 86-28-8665-5511

**China - Chongqing**  
Tel: 86-23-8980-9588

**China - Dongguan**  
Tel: 86-769-8702-9880

**China - Guangzhou**  
Tel: 86-20-8755-8029

**China - Hangzhou**  
Tel: 86-571-8792-8115

**China - Hong Kong SAR**  
Tel: 852-2943-5100

**China - Nanjing**  
Tel: 86-25-8473-2460

**China - Qingdao**  
Tel: 86-532-8502-7355

**China - Shanghai**  
Tel: 86-21-3326-8000

**China - Shenyang**  
Tel: 86-24-2334-2829

**China - Shenzhen**  
Tel: 86-755-8864-2200

**China - Suzhou**  
Tel: 86-186-6233-1526

**China - Wuhan**  
Tel: 86-27-5980-5300

**China - Xian**  
Tel: 86-29-8833-7252

**China - Xiamen**  
Tel: 86-592-2388138

**China - Zhuhai**  
Tel: 86-756-3210040

### ASIA/PACIFIC

**India - Bangalore**  
Tel: 91-80-3090-4444

**India - New Delhi**  
Tel: 91-11-4160-8631

**India - Pune**  
Tel: 91-20-4121-0141

**Japan - Osaka**  
Tel: 81-6-6152-7160

**Japan - Tokyo**  
Tel: 81-3-6880-3770

**Korea - Daegu**  
Tel: 82-53-744-4301

**Korea - Seoul**  
Tel: 82-2-554-7200

**Malaysia - Kuala Lumpur**  
Tel: 60-3-7651-7906

**Malaysia - Penang**  
Tel: 60-4-227-8870

**Philippines - Manila**  
Tel: 63-2-634-9065

**Singapore**  
Tel: 65-6334-8870

**Taiwan - Hsin Chu**  
Tel: 886-3-577-8366

**Taiwan - Kaohsiung**  
Tel: 886-7-213-7830

**Taiwan - Taipei**  
Tel: 886-2-2508-8600

**Thailand - Bangkok**  
Tel: 66-2-694-1351

**Vietnam - Ho Chi Minh**  
Tel: 84-28-5448-2100

### EUROPE

**Austria - Wels**  
Tel: 43-7242-2244-39  
Fax: 43-7242-2244-393

**Denmark - Copenhagen**  
Tel: 45-4485-5910  
Fax: 45-4485-2829

**Finland - Espoo**  
Tel: 358-9-4520-820

**France - Paris**  
Tel: 33-1-69-53-63-20  
Fax: 33-1-69-30-90-79

**Germany - Garching**  
Tel: 49-8931-9700

**Germany - Haan**  
Tel: 49-2129-3766400

**Germany - Heilbronn**  
Tel: 49-7131-72400

**Germany - Karlsruhe**  
Tel: 49-721-625370

**Germany - Munich**  
Tel: 49-89-627-144-0  
Fax: 49-89-627-144-44

**Germany - Rosenheim**  
Tel: 49-8031-354-560

**Israel - Ra'anana**  
Tel: 972-9-744-7705

**Italy - Milan**  
Tel: 39-0331-742611  
Fax: 39-0331-466781

**Italy - Padova**  
Tel: 39-049-7625286

**Netherlands - Drunen**  
Tel: 31-416-690399  
Fax: 31-416-690340

**Norway - Trondheim**  
Tel: 47-7288-4388

**Poland - Warsaw**  
Tel: 48-22-3325737

**Romania - Bucharest**  
Tel: 40-21-407-87-50

**Spain - Madrid**  
Tel: 34-91-708-08-90  
Fax: 34-91-708-08-91

**Sweden - Gothenberg**  
Tel: 46-31-704-60-40

**Sweden - Stockholm**  
Tel: 46-8-5090-4654

**UK - Wokingham**  
Tel: 44-118-921-5800  
Fax: 44-118-921-5820

# Mouser Electronics

Authorized Distributor

Click to View Pricing, Inventory, Delivery & Lifecycle Information:

## Microchip:

[MIC23031-AYMT TR](#) [MIC23031-FYMT TR](#) [MIC23031-CYMT TR](#) [MIC23031-4YMT TR](#) [MIC23031-GYMT TR](#)  
[MIC23031-FYMT-TR](#) [MIC23031-AYMT-TR](#) [MIC23031-CYMT-TR](#) [MIC23031-GYMT-TR](#) [MIC23031-4YMT-TR](#)