



Parameter	Rating	Units
Blocking Voltage	350	$V_P$
Load Current	100	$mA_{rms} / mA_{DC}$
On-Resistance (max)	35	$\Omega$

### Features

- 3750V<sub>rms</sub> Input/Output Isolation
- Three Functions in One Package
- Bidirectional Current Sensing
- Bidirectional Current Switching
- FCC Compatible
- No EMI/RFI Generation
- Small 16-Pin SOIC Package (PCMCIA Compatible)
- Machine Insertable, Wave Solderable
- Tape & Reel Version Available

### Applications

- Telecommunications
  - Telecom Switching
  - Tip/Ring Circuits
  - Modem Switching (Laptop, Notebook, Pocket Size)
  - Hook Switch
  - Dial Pulsing
  - Ground Start
  - Ringing Injection
- Instrumentation
  - Multiplexers
  - Data Acquisition
  - Electronic Switching
  - I/O Subsystems
- Meters (Watt-Hour, Water, Gas)
- Medical Equipment-Patient/Equipment Isolation
- Security
- Aerospace
- Industrial Controls

### Description

The IAA110P Multifunction Telecom switch combines two 350V normally open (1-Form-A) relays and one optocoupler in a single package. The relays use optically coupled MOSFET technology to provide 3750V<sub>rms</sub> of input to output isolation. The efficient MOSFET switches and photovoltaic die use IXYS Integrated Circuits Division's patented OptoMOS architecture while the inputs' highly efficient GaAlAs infrared LEDs control the outputs. The IAA110P allows telecom circuit designers to combine three discrete functions in a single component that occupies less space than traditional discrete component solutions.

### Approvals

- UL Recognized Component: File E76270
- CSA Certified Component: Certificate 1305490
- EN/IEC 60950-1 Certified Component:  
TUV Certificate: B 12 11 82667 002

### Ordering Information

Part #	Description
IAA110P	16-Pin SOIC (50/Tube)
IAA110PTR	16-Pin SOIC (1000/Reel)

### Pin Configuration

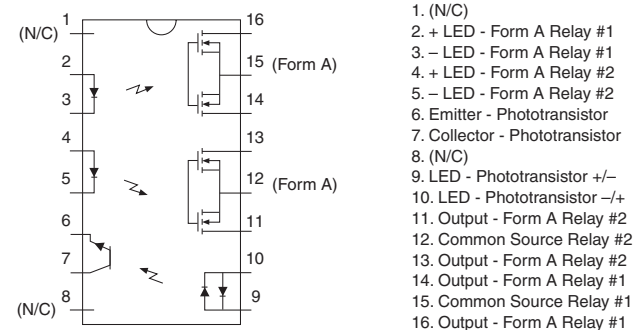

### Switching Characteristics of Normally Open Devices

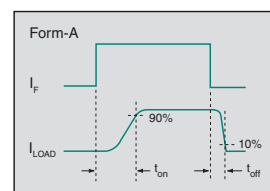

**Absolute Maximum Ratings @ 25°C**

Parameter	Ratings	Units
Input Control Current, Relay	50	mA
Total Package Dissipation <sup>1</sup>	1	W
Isolation Voltage, Input to Output	3750	V <sub>rms</sub>
Operational Temperature	-40 to +85	°C
Storage Temperature	-40 to +125	°C

<sup>1</sup> Derate linearly 1.67 mW / °C

*Absolute Maximum Ratings are stress ratings. Stresses in excess of these ratings can cause permanent damage to the device. Functional operation of the device at conditions beyond those indicated in the operational sections of this data sheet is not implied.*

**Electrical Characteristics @25°C: Relay Section**

Parameter	Conditions	Symbol	Min	Typ	Max	Units
<b>Output Characteristics</b>						
Blocking Voltage (Peak)	I <sub>L</sub> =1μA	V <sub>L</sub>	-	-	350	V <sub>P</sub>
Load Current						
Continuous	-	I <sub>L</sub>	-	-	100	mA <sub>rms</sub> / mA <sub>DC</sub>
Peak	t=10ms	I <sub>LPK</sub>	-	-	350	mA <sub>P</sub>
On-Resistance	I <sub>L</sub> =100mA	R <sub>ON</sub>	-	-	35	Ω
Off-State Leakage Current	V <sub>L</sub> =350V, T <sub>J</sub> =25°C	I <sub>LEAK</sub>	-	-	1	μA
<b>Switching Speeds</b>						
Turn-On	I <sub>F</sub> =5mA, V <sub>L</sub> =10V	t <sub>on</sub>	-	-	3	ms
Turn-Off		t <sub>off</sub>	-	-	3	ms
Output Capacitance	V <sub>L</sub> =50V, f=1MHz	C <sub>OUT</sub>	-	25	-	pF
<b>Input Characteristics</b>						
Input Control Current to Activate	I <sub>L</sub> =100mA	I <sub>F</sub>	-	-	5	mA
Input Control Current to Deactivate	I <sub>L</sub> =1mA	I <sub>F</sub>	0.4	-	-	mA
Input Voltage Drop	I <sub>F</sub> =5mA	V <sub>F</sub>	0.9	1.2	1.4	V
Reverse Input Voltage	-	V <sub>R</sub>	-	-	5	V
Reverse Input Current	V <sub>R</sub> =5V	I <sub>R</sub>	-	-	10	μA

**Electrical Characteristics @25°C: Detector Section**

Parameter	Conditions	Symbol	Min	Typ	Max	Units
<b>Output Characteristics</b>						
Phototransistor Blocking Voltage	I <sub>C</sub> =10μA	BV <sub>CEO</sub>	20	50	-	V
Phototransistor Dark Current	V <sub>CE</sub> =5V, I <sub>F</sub> =0mA	I <sub>CEO</sub>	-	50	500	nA
Saturation Voltage	I <sub>C</sub> =2mA, I <sub>F</sub> =16mA	V <sub>SAT</sub>	-	0.3	0.5	V
Current Transfer Ratio	I <sub>F</sub> =6mA, V <sub>CE</sub> =0.5V	CTR	33	-	-	%
<b>Input Characteristics</b>						
Input Control Current	I <sub>C</sub> =2mA, V <sub>CE</sub> =0.5V	I <sub>F</sub>	-	2	6	mA
Input Voltage Drop	I <sub>F</sub> =5mA	V <sub>F</sub>	0.9	1.2	1.4	V
Input Current (Detector Must be Off)	I <sub>C</sub> =1μA, V <sub>CE</sub> =5V	-	5	25	-	μA
Capacitance, Input to Output	V <sub>L</sub> =50V, f=1MHz	C <sub>I/O</sub>	-	3	-	pF
Isolation, Input to Output	-	V <sub>I/O</sub>	3750	-	-	V <sub>rms</sub>

**COMMON PERFORMANCE DATA\***

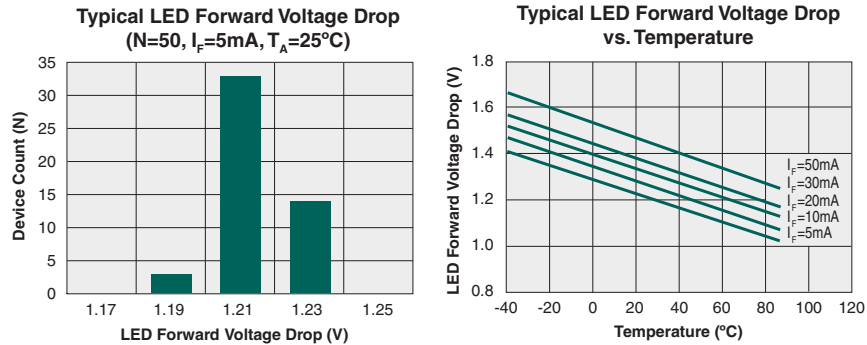

**RELAY PERFORMANCE DATA\***

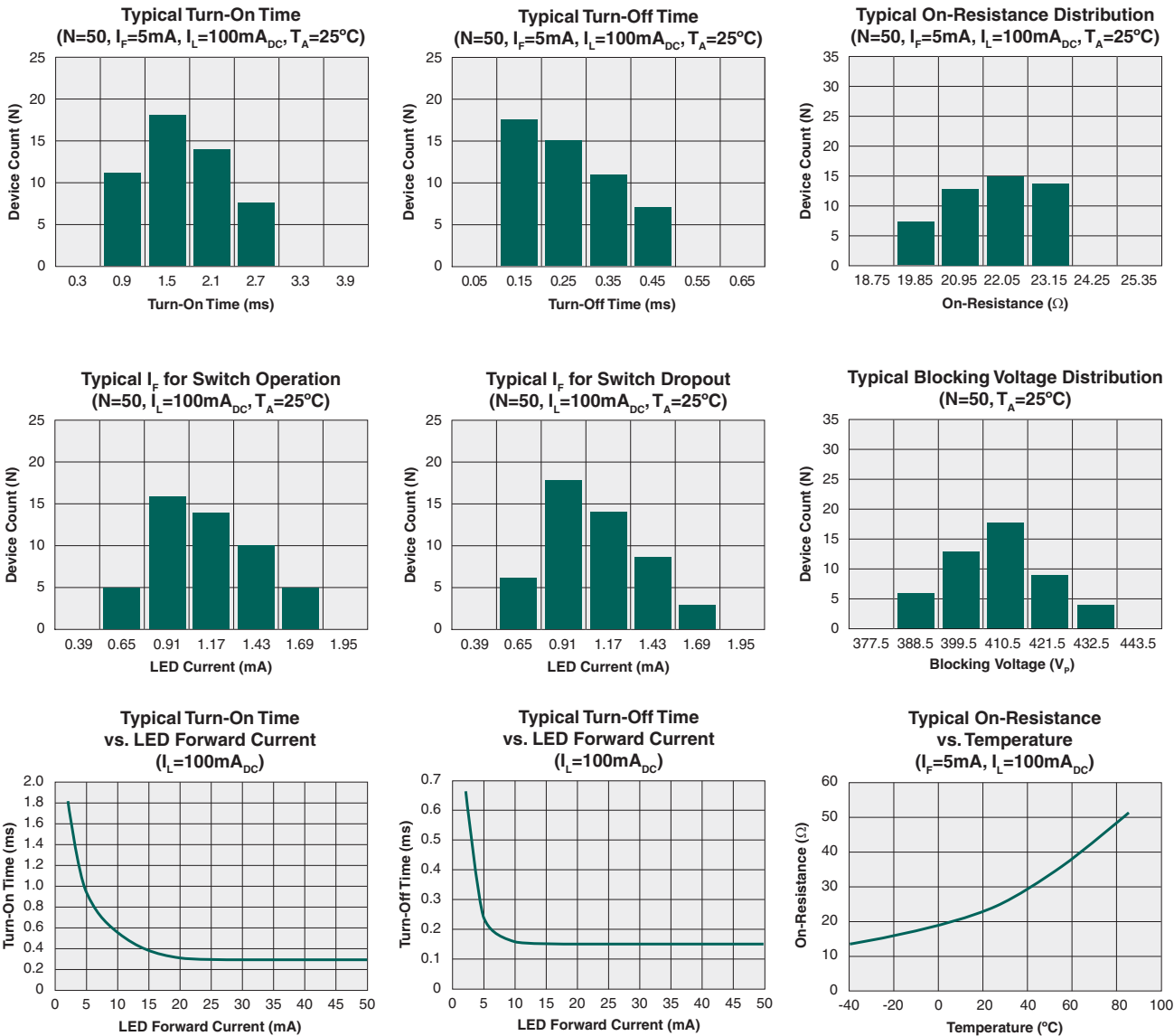

\* The Performance data shown in the graphs above is typical of device performance. For guaranteed parameters not indicated in the written specifications, please contact our application department.

**RELAY PERFORMANCE DATA (cont.)\***

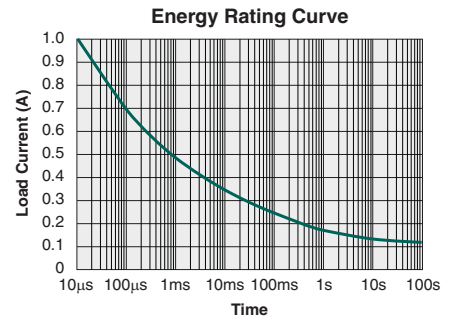
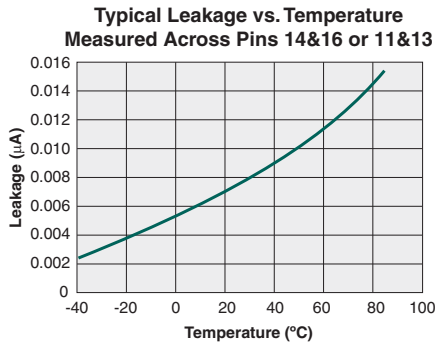
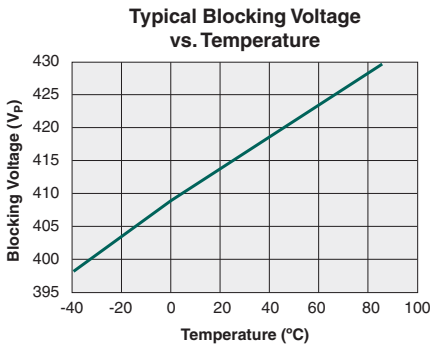
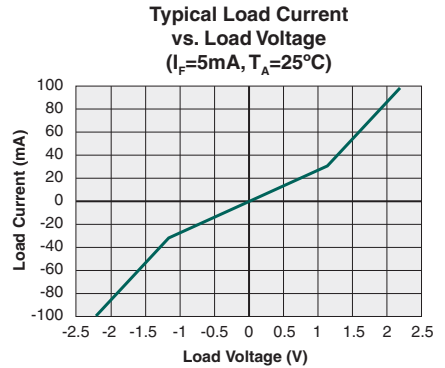
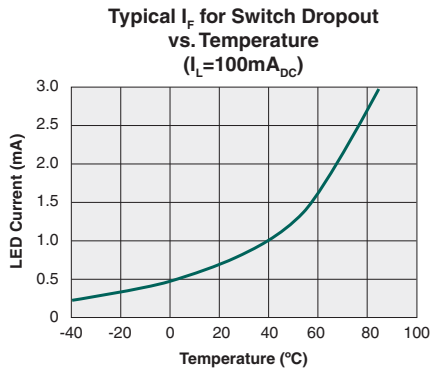
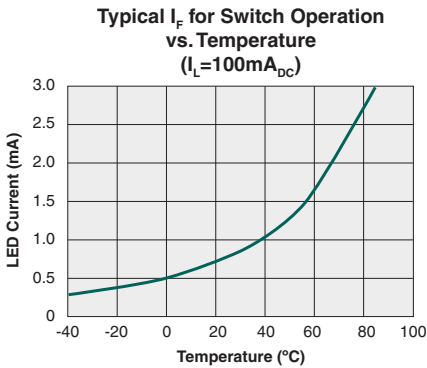
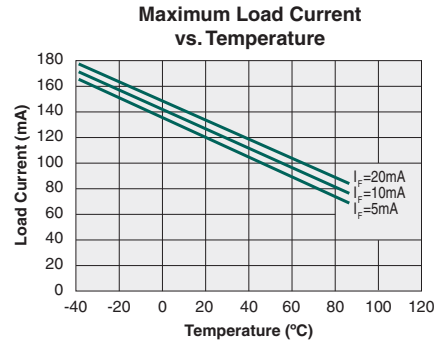
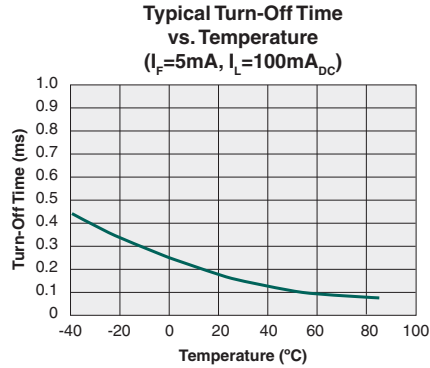
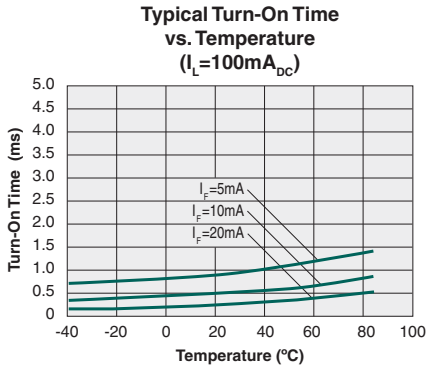

**DETECTOR PERFORMANCE DATA \***

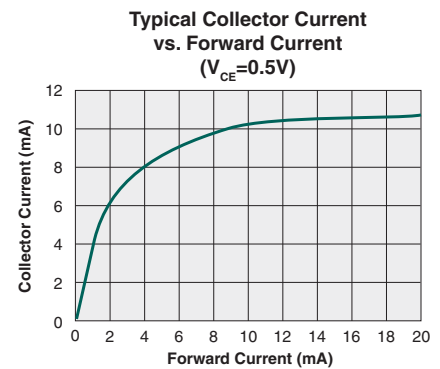
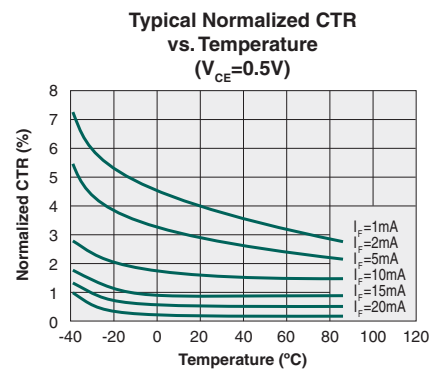
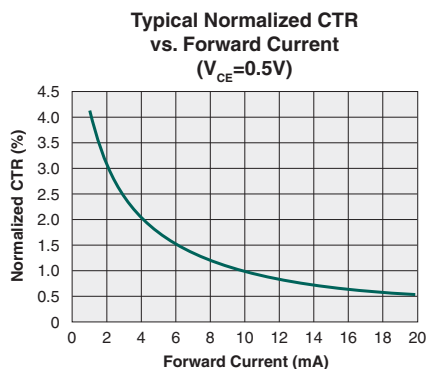

\* The Performance data shown in the graphs above is typical of device performance. For guaranteed parameters not indicated in the written specifications, please contact our application department.

**Manufacturing Information**

**Moisture Sensitivity**



All plastic encapsulated semiconductor packages are susceptible to moisture ingress. IXYS Integrated Circuits Division classified all of its plastic encapsulated devices for moisture sensitivity according to the latest version of the joint industry standard, **IPC/JEDEC J-STD-020**, in force at the time of product evaluation. We test all of our products to the maximum conditions set forth in the standard, and guarantee proper operation of our devices when handled according to the limitations and information in that standard as well as to any limitations set forth in the information or standards referenced below.

Failure to adhere to the warnings or limitations as established by the listed specifications could result in reduced product performance, reduction of operable life, and/or reduction of overall reliability.

This product carries a **Moisture Sensitivity Level (MSL) rating** as shown below, and should be handled according to the requirements of the latest version of the joint industry standard **IPC/JEDEC J-STD-033**.

Device	Moisture Sensitivity Level (MSL) Rating
IAA110P	MSL 1

**ESD Sensitivity**



This product is **ESD Sensitive**, and should be handled according to the industry standard **JESD-625**.

**Reflow Profile**

This product has a maximum body temperature and time rating as shown below. All other guidelines of **J-STD-020** must be observed.

Device	Maximum Temperature x Time
IAA110P	260°C for 30 seconds

**Board Wash**

IXYS Integrated Circuits Division recommends the use of no-clean flux formulations. However, board washing to remove flux residue is acceptable. Since IXYS Integrated Circuits Division employs the use of silicone coating as an optical waveguide in many of its optically isolated products, the use of a short drying bake could be necessary if a wash is used after solder reflow processes. Chlorine- or Fluorine-based solvents or fluxes should not be used. Cleaning methods that employ ultrasonic energy should not be used.



**MECHANICAL DIMENSIONS**

**IAA110P**

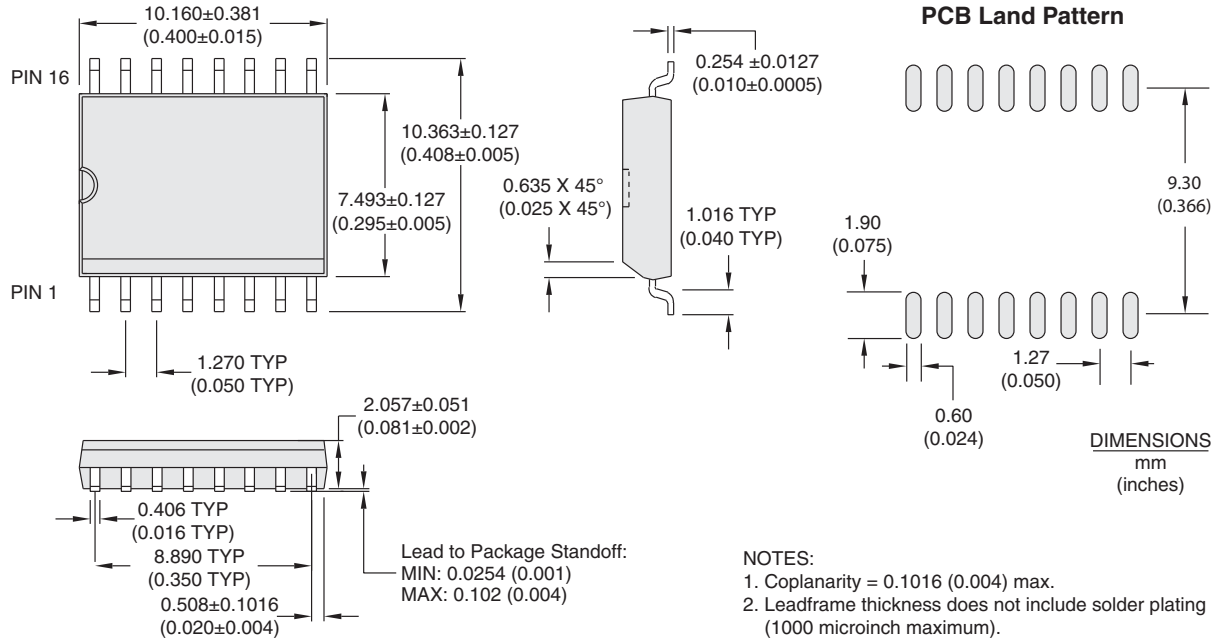

**IAA110PTR Tape & Reel**

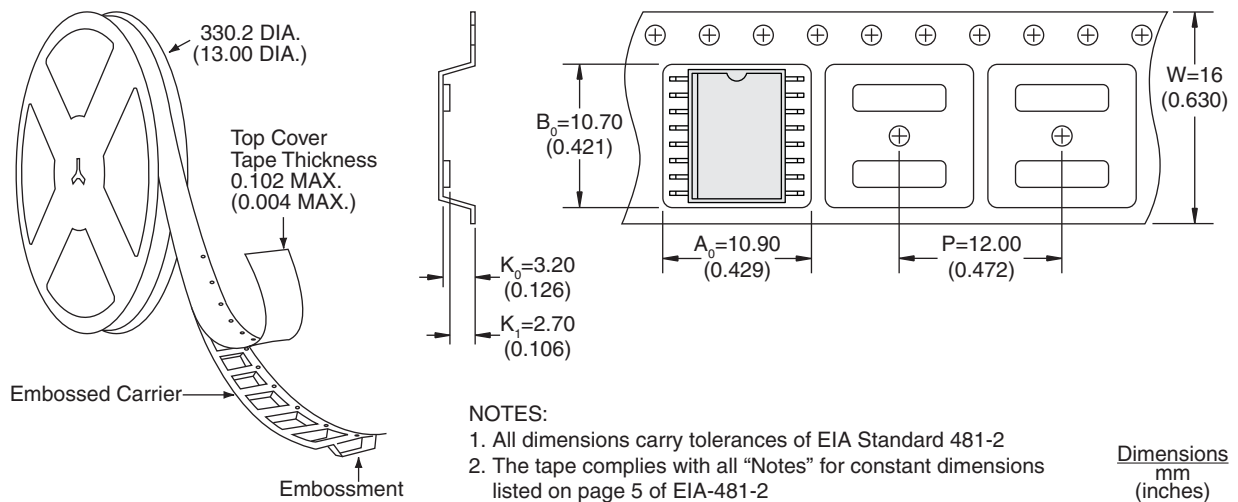

For additional information please visit our website at: [www.ixysic.com](http://www.ixysic.com)

IXYS Integrated Circuits Division makes no representations or warranties with respect to the accuracy or completeness of the contents of this publication and reserves the right to make changes to specifications and product descriptions at any time without notice. Neither circuit patent licenses nor indemnity are expressed or implied. Except as set forth in IXYS Integrated Circuits Division's Standard Terms and Conditions of Sale, IXYS Integrated Circuits Division assumes no liability whatsoever, and disclaims any express or implied warranty, relating to its products including, but not limited to, the implied warranty of merchantability, fitness for a particular purpose, or infringement of any intellectual property right.

The products described in this document are not designed, intended, authorized or warranted for use as components in systems intended for surgical implant into the body, or in other applications intended to support or sustain life, or where malfunction of IXYS Integrated Circuits Division's product may result in direct physical harm, injury, or death to a person or severe property or environmental damage. IXYS Integrated Circuits Division reserves the right to discontinue or make changes to its products at any time without notice.

# Mouser Electronics

Authorized Distributor

Click to View Pricing, Inventory, Delivery & Lifecycle Information:

[IXYS:](#)

[IAA110P](#) [IAA110PTR](#)